





Prese ad Innesto Rapido - Quick Couplings - Schnellverschluss Kupplungen - Coupleurs Automatiques - Enchufes Rápidos - Conexões de Engate Rápido

<p>SERIE UNI ISO 6150 A-6</p>  <p>Serie 100 Pag. 15.7 - 15.10</p>	<p>SERIE MIGNON New</p>  <p>Serie 110 Pag. 15.11 - 15.16</p>	<p>SERIE UNI ISO 6150 B-12</p>  <p>Serie 120 Pag. 15.17 - 15.22</p>	<p>ITALIAN PROFILE</p>  <p>Serie 120 Pag. 15.23 - 15.28</p>
<p>SERIE UNI ISO 6150 B-15</p>  <p>Serie 130 Pag. 15.29 - 15.33</p>	<p>SERIE UNI ISO 6150 C-10</p>  <p>Serie 140 Pag. 15.34 - 15.39</p>	<p>EUROPEAN PROFILE</p>  <p>Serie 160 Pag. 15.40 - 15.45</p>	<p>SWISS PROFILE</p>  <p>Serie 170 Pag. 15.46 - 15.50</p>
<p>MIGNON PROFILE New</p>  <p>Serie 180 Pag. 15.51 - 15.54</p>	<p>MULTISOCKET New</p>  <p>Serie 190 - 63190 Pag. 15.55 - 15.61</p>	<p>JAPANESE PROFILE</p>  <p>Serie 400 Pag. 15.62 - 15.64</p>	<p>Serie 700 Pag. 15.65 - 15.67</p>
<p>SERIE UNI ISO 6150 B-17</p>  <p>Serie 710 Pag. 15.68 - 15.70</p>	<p>B-SOCKET EUROPEAN</p>  <p>Serie 720 Pag. 15.71 - 15.74</p>	<p>EUROPEAN PROFILE New</p>  <p>Serie 730 Pag. 15.75 - 15.80</p>	<p>EUROPEAN PROFILE New</p>  <p>Serie 740 Pag. 15.81 - 15.83</p>

Prese di Sicurezza ad Innesto Rapido - Safety Quick Couplings - Kupplungen Sicherheit - Coupleurs de Sécurité - Enchufes de Seguridad - Conexões de Segurança

<p>SERIE UNI ISO 6150 B-12</p>  <p>Serie 620 Pag. 15.85 - 15.88</p>	<p>ITALIAN PROFILE</p>  <p>Serie 650 Pag. 15.89 - 15.90</p>	<p>EUROPEAN PROFILE</p>  <p>Serie 660 Pag. 15.91 - 15.92</p>	<p>SWISS PROFILE</p>  <p>Serie 670 Pag. 15.93 - 15.94</p>
<p>SERIE UNI ISO 6150 B-12</p>  <p>Serie 0B120 Pag. 15.97 - 15.99</p>	<p>SERIE UNI ISO 6150 C-10</p>  <p>Serie 0B140 Pag. 15.100 - 15.102</p>	<p>EUROPEAN PROFILE New</p>  <p>Serie 0B160 Pag. 15.103 - 15.105</p>	

Giunti ad Innesto Rapido per Raffreddamento Stampi - Quick Couplings for Molding Cooling - Schnellkupplungen für Spritzgussanwendungen - Coupleurs pour Mouldes D'injection - Enchufes Rápidos para Refrigeración de Moldes - Conexões de Engate Rápido para Resfriamento de Moldes

<p>FRENCH PROFILE DN 8 - DN 12</p>  <p>Series 410 - 420 - 510 - 520 Pag. 15.104 - 15.110</p>	<p>INTERNATIONAL PROFILE DN 6 - DN 9</p>  <p>Series 430 - 440 - 530 - 540 Pag. 15.112 - 15.119</p>	<p>EUROPEAN PROFILE DN 6 - DN 9</p>  <p>Series 460 - 470 - 560 - 570 Pag. 15.120 - 15.127</p>	<p>6049 Pag. 15.128</p> 
--	--	--	--

Pistole di Soffiaggio - Blow Guns - Blaspistolen - Soufflettes - Pistolas Sopladoras - Pistola de Ar

 <p>Series 360 Pag. 15.130 - 15.132</p>	 <p>Series 300 Pag. 15.133 - 15.135</p>	 <p>Spare Parts Pag. 15.136</p>	 <p>Series 340 Pag. 15.137</p>
---	---	--	--

Alignep si riserva il diritto di variare modelli e ingombri senza preavviso - Alignep reserves the right to vary models and dimensions without notice - Alignep behält sich das Recht vor, Daten ohne Ankündigung zu ändern
 Alignep se reserva el derecho de modificar modelos y dimensiones sin previo aviso - Alignep se réserve le droit de modifier les données sans préavis

New

SERIE OB160 EUROPEAN PROFILE



CARATTERISTICHE TECNICHE
 TECHNICAL CHARACTERISTICS
 TECHNISCHE ANGABEN
 CARACTÉRISTIQUES TECHNIQUES
 CARACTERÍSTICAS TÉCNICAS
 CARACTERÍSTICAS TÉCNICAS



Norma di Riferimento
 Reference standard
 Entspricht der Norm
 Norme de référence
 Normativa de referencia
 Norma de referència

1907/2006 REACH ✓	2011/65/CE RoHS ✓	ISO 4414
PED 2014/68/UE	SILICON FREE	

CONSIGLIATA CON INNESTI ACCIAIO
 ADVISE WITH STEEL PLUG
 EMPFOHLENE STECKER AUS STAHL
 EMBOUT RECOMMANDE EN ACIER
 ACONSEJADOS CON ADAPT EN ACERO
 ACONSELHADA COM PLUG EM AÇO

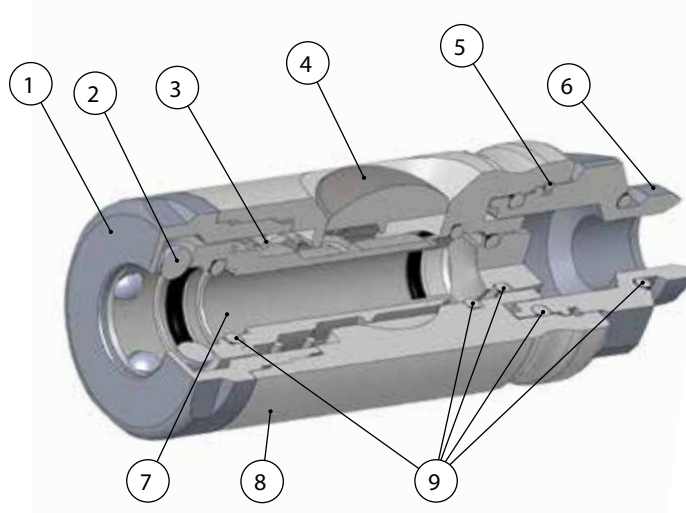

ORIENTABILE
 ORIENTING
 DREHBAR
 ORIENTABLE
 ORIENTABLE
 ORIENTÁVEL

DN
7.8 mm

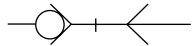

EUROPEAN

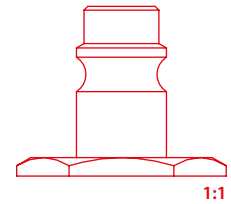

Materiali e Componenti	IT	Component Parts and Materials	GB	Komponenten und Materialien	DE
1 Anello in ottone nichelato		1 Nickel-plated brass ring		1 Führungsring Messing vernickelt	
2 Sfera in acciaio INOX AISI 420		2 INOX steel AISI 420 ball		2 Kugel Edelstahl AISI 420	
3 Molla contrasto otturatore in acciaio INOX AISI 302		3 INOX steel AISI 302 shutter thrust spring		3 Verschlussfeder Edelstahl AISI 302	
4 Pulsante in acciaio		4 Steel button		4 Stahl Knopf	
5 Anello in ottone		5 Brass ring		5 Führungsring Messing	
6 Attacco terminale in ottone nichelato		6 Nickel-plated brass coupling back part		6 Einschraubkörper Messing vernickelt	
7 Otturatore in acciaio		7 Steel shutter		7 Verschluss Stahl	
8 Corpo in alluminio		8 Aluminium Body		8 Körper Aluminium	
9 Guarnizione O-Ring in NBR		9 NBR O-ring		9 O-Ring NBR	

Matériaux et Composants	FR	Materiales y Componentes	ES	Materiais e Componentes	PT
1 Bague de guidage: laiton nickelé		1 Anillo en latón niquelado		1 Anel em Latão Niquelado	
2 Bille: acier inoxydable AISI 420		2 Esfera en acero INOX AISI 420		2 Esfera em aço INOX AISI 420	
3 Ressort de bague: acier inoxydable AISI 302		3 Muelle empuje obturador en acero INOX AISI 302		3 Mola do obturador em aço INOX AISI 302	
4 Bouton en acier		4 Botón de acero		4 Botão de aço	
5 Bague de guidage: laiton		5 Anillo en latón		5 Anel em Latão	
6 Corps: laiton nickelé		6 Terminal en latón niquelado		6 Conexão terminal em Latão Niquelado	
7 Clapet: Acier		7 Obturador en Acero		7 Obturador em Aço	
8 Corps: Aluminium		8 Cuerpo en Aluminio		8 Corpo em Alumínio	
9 Joint torrique: NBR		9 Junta tórica en NBR		9 Vedação O-Ring em NBR	



Pressione d'esercizio

Working Pressures

Betriebsdruck

Pression de service

Presión de Ejercicio

Pressão de Trabalho

0 bar (0 MPa)

15 bar (1.5 MPa)



Temperature

Temperatures

Temperatur

Températures

Temperaturas

Temperaturas

- 20 °C

+ 80 °C



Fluidi compatibili

Aria compressa

Fluids

Compressed air

Geeignete Medien

Druckluft

Fluides compatibles

Air comprimé

Fluidos compatibles

Aire comprimido

Fluidos compatíveis

Ar comprimido



Portata

NI/min

Flow Rate

Durchflusswerte

Débit

Caudal de Flujo

Vazão

6 bar

Δ 1

6 bar

Δ 0.5

6 bar

970

1310

2000

* Scarico libero - Exhaust Free - Kostenlose Auspuff - Échappement libre - Escape Libre - Descarga libre.



Filettatura

Gas cilindrica conforme ISO 228 Classe A.

IT

Threads

Parallel gas in conformity with ISO 228 Class A.

GB

Gewindearten

Zylindrisches Gewinde nach Norm ISO 228 Classe A.

DE

Filetages

Filetage cylindrique conforme: ISO 228 Class A.

FR

Roscas

Gas cilindrica conforme ISO 228 Clase A.

ES

Roscas

Gas paralela conforme ISO 228 Classe A.

PT

OB161

PRESA DI SICUREZZA MASCHIO CILINDRICO CON OR

SAFETY MALE CILINDRIC SOCKET WITH OR

VERSCHLUSS-KUPPLUNG SICHERHEIT MIT AUSSENGEWINDE ZYLINDRISCH MIT OR

COUPLEUR DE SÉCURITÉ MÂLE CYLINDRIQUE AVEC OR

ENCHUFE DE SEGURIDAD MACHO CILINDRICA CON OR

SOQUETE DE SEGURANÇA COM ROSCA MACHO PARALELA COM OR

Code	A	B	C	D	CH	Pack.
OB161 00 001	1/4	8	73	26	21	10
OB161 00 002	3/8	9	74	26	21	10
OB161 00 003	1/2	10	77	26	25	10

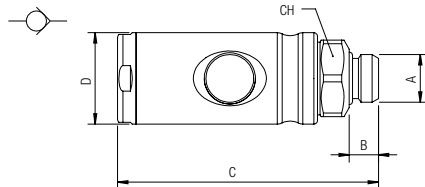

OB162

PRESA DI SICUREZZA FEMMINA

SAFETY FEMALE CILINDRIC SOCKET

VERSCHLUSS-KUPPLUNG SICHERHEIT MIT INNENGEWINDE

COUPLEUR DE SÉCURITÉ FEMELLE

ENCHUFE DE SEGURIDAD HEMBRA

SOQUETE DE SEGURANÇA COM ROSCA FÊMEA

Code	A	B	C	D	CH	Pack.
OB162 00 001	1/4	9	71	26	21	10
OB162 00 002	3/8	12	74	26	21	10
OB162 00 003	1/2	15	78	26	24	10

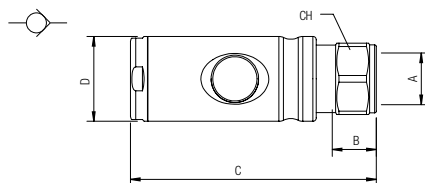

OB165

PRESA DI SICUREZZA PORTAGOMMA

SAFETY SOCKET FOR RUBBER HOSE
 STECKER SICHERHEIT FÜR GUMMISCHLAUCH
 COUPLEUR DE SECURITE POUR TUYAU
 ENCHUFE DE SEGURIDAD CON PORTAGOMA
 SOQUETE DE SEGURANÇA COM ESPIGÃO PARA TUBO DE BORRACHA

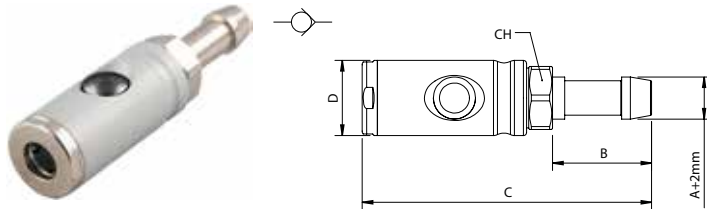

Code	A	B	C	D	CH	Pack.
OB165 00 001	6	27.5	92.5	26	21	10
OB165 00 002	8	27.5	92.5	26	21	10
OB165 00 003	10	27.5	92.5	26	21	10
OB165 00 004	12	33	98	26	21	10

261AC DN 7.8

INNESTO IN ACCIAIO MASCHIO

STEEL MALE PLUG
 STECKER MIT AUSSERGEWINDE AUS STAHL
 EMBOUT MÂLE EN ACIER
 ADAPTADOR EN ACERO MACHO
 PLUG EM AÇO COM ROSCA MACHO

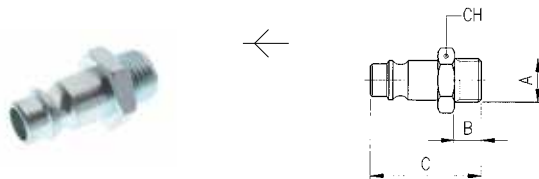

Code	A	B	C	CH	Pack.
261AC 00 51 03 ZI	1/4	8	33	17	10
261AC 00 51 04 ZI	3/8	9	34	19	10
261AC 00 51 05 ZI	1/2	10	35.5	24	10

Acciaio Indurito
 Hardened Steel
 Gehärtetem Stahl
 Acier Trempé
 Acero Curtido
 Aço Endurecido

262AC DN 7.8

INNESTO IN ACCIAIO FEMMINA

STEEL FEMALE PLUG
 STECKER MIT INNENGEWINDE AUS STAHL
 EMBOUT FEMELLE EN ACIER
 ADAPTADOR EN ACERO HEMBRA
 PLUG EM AÇO COM ROSCA FÊMEA

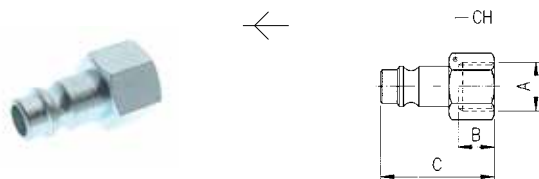

Code	A	B	C	CH	Pack.
262AC 00 51 03 ZI	1/4	11	33	17	10
262AC 00 51 04 ZI	3/8	11.5	33.5	19	10
262AC 00 51 05 ZI	1/2	14	36	24	10

Acciaio Indurito
 Hardened Steel
 Gehärtetem Stahl
 Acier Trempé
 Acero Curtido
 Aço Endurecido

265AC DN 7.8

INNESTO IN ACCIAIO CON PORTAGOMMA A RESCA

STEEL BARBED PLUG
 STECKER MIT SCHLAUCHTÜLLE AUS STAHL
 EMBOUT À DOUILLE ANNELÉE POUR TUBE EN ACIER
 ADAPTADOR EN ACERO ESPIGA
 PLUG EM AÇO COM ESPIGÃO PARA TUBO DE BORRACHA

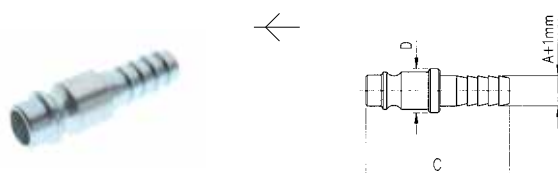

Code	A	C	D	Pack.
265AC 00 51 X4 ZI	6	39.5	12	10
265AC 00 51 X7 ZI	8	39.5	12	10
265AC 00 51 X9 ZI	10	42.5	14	10
265AC 00 51 Y1 ZI	12	42.5	16	10

Acciaio Indurito
 Hardened Steel
 Gehärtetem Stahl
 Acier Trempé
 Acero Curtido
 Aço Endurecido