

Check Valve with One-Touch Fitting

Series *AKH/AKB*

3 configurations provide design solutions based on the operating conditions

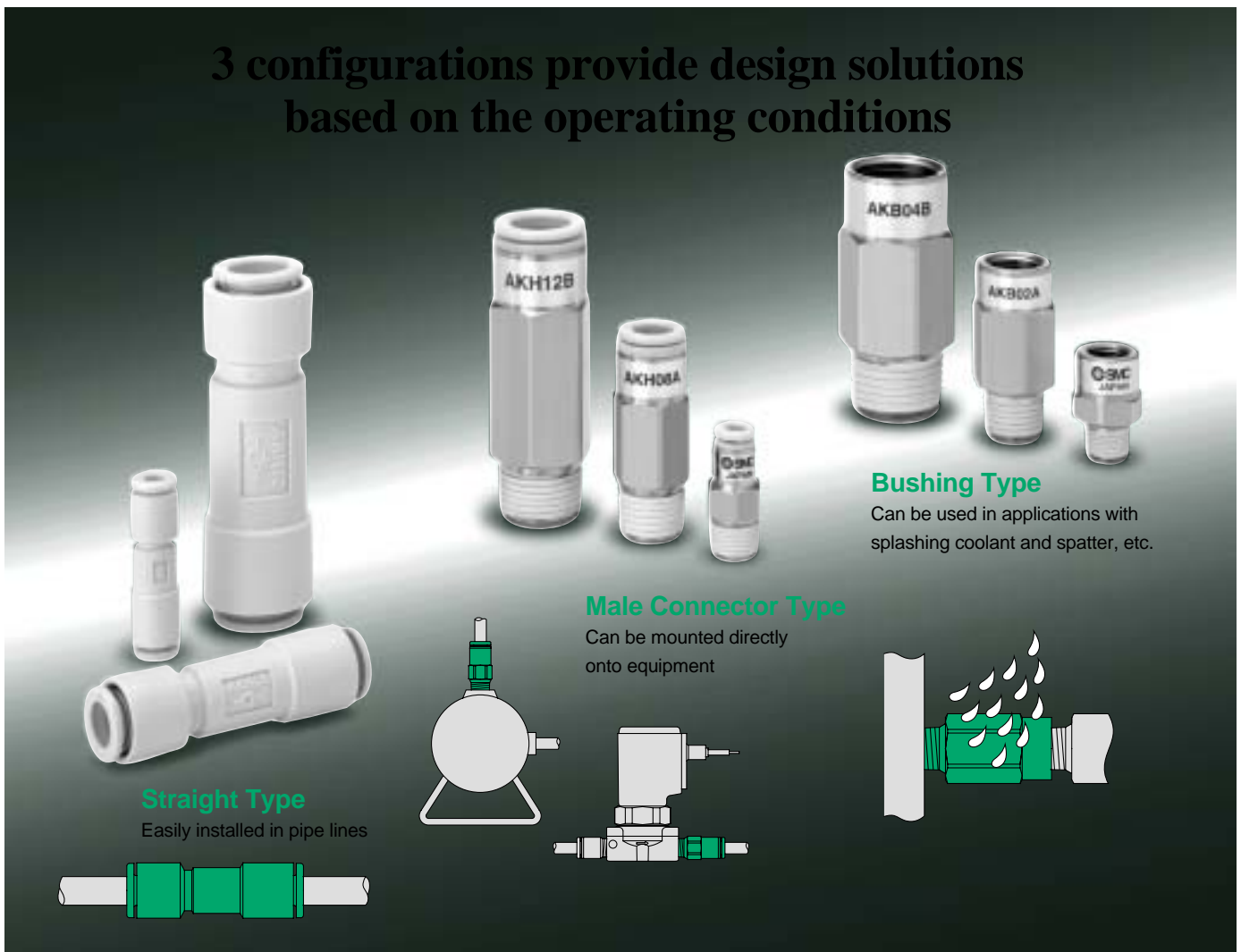

Straight Type

Easily installed in pipe lines

Male Connector Type

Can be mounted directly onto equipment

Bushing Type

Can be used in applications with splashing coolant and spatter, etc.

Symbol

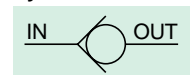

Can be used for vacuum (-100kPa)

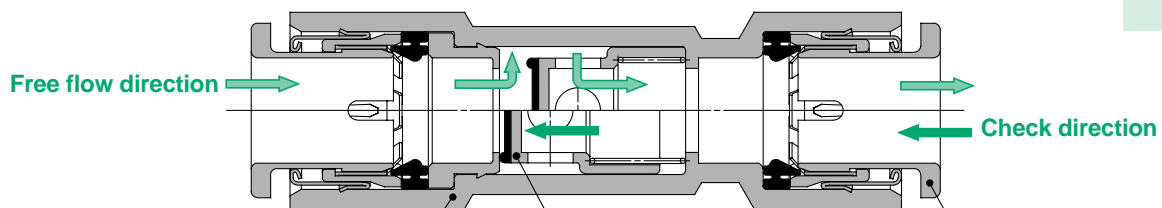

Compact & Light weight

Outside diameter: $\varnothing 11.6\text{mm}$
 Overall length: 37.1mm
 Weight: 5g
 (for AKH06-00)

Valve

Low cracking pressure: 0.005MPa
 Large effective area: 3 to 34mm²

With One-touch fitting

Reduces piping labour
 Release bushing colour
 Millimeter size: White
 Inch size: Orange

Check Valve with One-Touch Fitting Series **AKH/AKB**

How to Order

Straight Type AKH 04 - 00
Male Connector Type AKH 04 A - 01 S

Applicable tube O.D.

Millimeter size		Inch size	
04	ø4	03	ø5/32
06	ø6	07	ø1/4
08	ø8	09	ø5/16
10	ø10	11	ø3/8
12	ø12	13	ø1/2

Check valve free flow direction

A	From male thread to One-touch fitting	
B	From One-touch fitting to male thread	

• With sealant (standard)

* Not applicable to types M5 & 10-32UNF are not required.

Thread type

Nil	Metric system thread (M5)
	Unified thread (10-32UNF)
	R(PT)
N	NPT

Port size

M5	M5 x 0.8
U10/32	10-32UNF
01	1/8
02	1/4
03	3/8
04	1/2

Applicable Tube O.D. /Port Size Combinations

Millimeter size

Model	Applicable tube O.D.	Port size R(PT)				
		M5	1/8	1/4	3/8	1/2
AKH04□	ø4	●	●			
AKH06□	ø6	●	●	●		
AKH08□	ø8		●	●	●	
AKH10□	ø10			●	●	●
AKH12□	ø12				●	●

Inch size

Model	Applicable tube O.D.	Port size NPT				
		10-32 UNF	1/8	1/4	3/8	1/2
AKH03□	ø5/32	●	●			
AKH07□	ø1/4	●	●	●		
AKH09□	ø5/16		●	●	●	
AKH11□	ø3/8			●	●	●
AKH13□	ø1/2				●	●

Bushing Type AKB 01 A - 01 S

Body size

01	1/8
02	1/4
03	3/8
04	1/2

Check valve free flow direction

A	From male thread to female thread	
B	From female thread to male thread	

• With sealant (standard)

Thread type

Nil	R(PT)
N	NPT

Port size

01	1/8
02	1/4
03	3/8
04	1/2

Female Thread/Male Thread Combinations

R(PT) thread

Model	Female thread Rc(PT)	Male thread R(PT)			
		1/8	1/4	3/8	1/2
AKB01□	1/8	●			
AKB02□	1/4		●		
AKB03□	3/8			●	
AKB04□	1/2				●

NPT thread

Model	Female thread NPT	Male thread NPT			
		1/8	1/4	3/8	1/2
AKB01□	1/8	●			
AKB02□	1/4		●		
AKB03□	3/8			●	
AKB04□	1/2				●

Check Valve with One-Touch Fitting *Series AKH/AKB*



Specifications

Fluid	Air
Proof pressure	1.5MPa
Operating pressure range	- 100kPa to 1MPa
Cracking pressure	0.005MPa
Ambient and fluid temperature	- 5 to 60°C (with no freezing)
Applicable tube material ^{Note 1)}	Nylon, Soft nylon, Polyurethane

Note 1) Use caution at the maximum operating pressure with soft nylon and polyurethane.
(Refer to CAT.E501-③ "Air Fittings and Tubing" for details.)

Application Examples for Check Valve with One-Touch Fitting

Prevention of reverse flow to vacuum source* (simple vacuum holding)

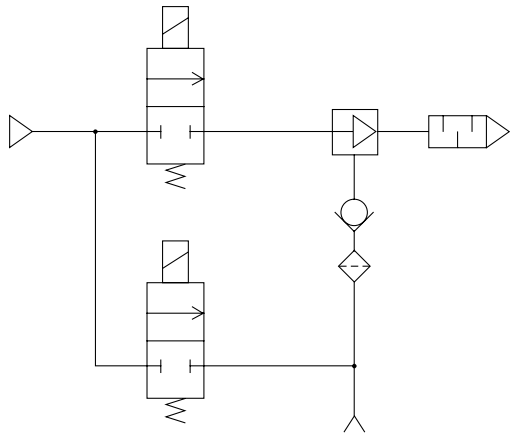

Tank pressure reverse flow prevention

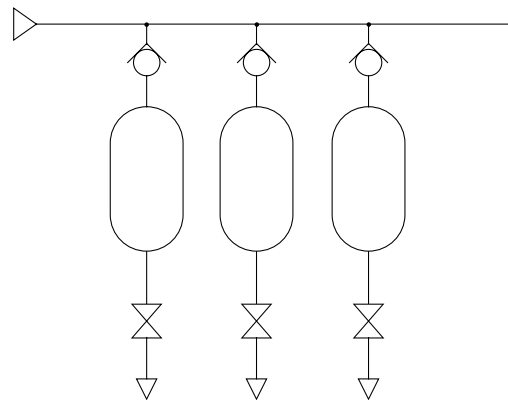

Drop prevention*

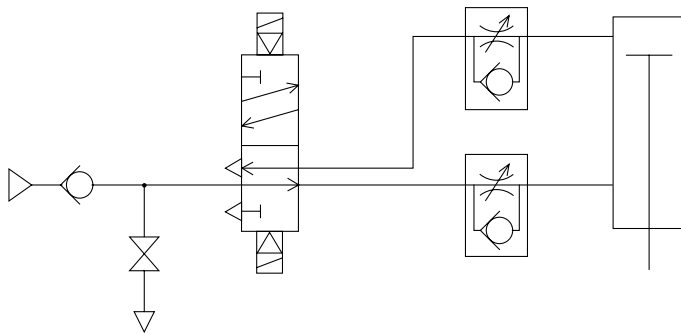

* A certain amount of leakage is allowed in the specifications of this product. Please note that it is not suitable for holding over an extended period of time.

Series AKH/AKB

Dimensions

Straight Type: AKH

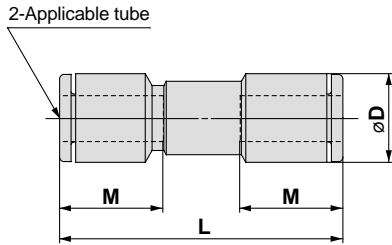

Millimeter Size

Applicable tube O.D.	Model	øD	L	M	Effective area (mm ²)	Weight g
4	AKH04-00	9.3	33.5	12.7	2.8	3
6	AKH06-00	11.6	37.1	13.5	6.5	5
8	AKH08-00	15.2	53.3	18.5	14	10
10	AKH10-00	18.5	63.6	21	24	17
12	AKH12-00	21.7	70.2	22	34	25

Inch Size

Applicable tube O.D.	Model	øD	L	M	Effective area (mm ²)	Weight g
5/32	AKH03-00	9.3	33.5	12.7	2.8	3
1/4	AKH07-00	12	39	13.6	6.5	6
5/16	AKH09-00	15.2	53.3	18.5	14	10
3/8	AKH11-00	18.5	63.6	21	24	17
1/2	AKH13-00	21.7	70.2	22	34	24

Male Connector Type: AKH

<For M5, UNF10-32>

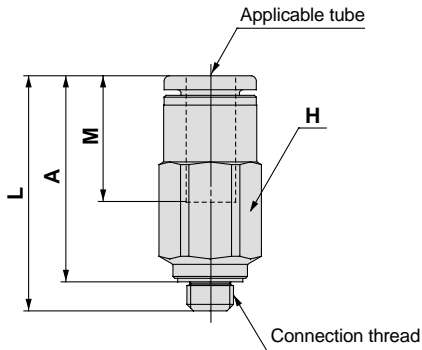

Millimeter Size

Applicable tube O.D.	Connection thread R(PT)	Model	H (Width across flats)	L	A *	M	Effective area (mm ²)	Weight g
4	M5 x 0.8	AKH04□-M5	8	24.3	21.2	12.7	2.8	5
	1/8	AKH04□-01S	10	24.6	20.6			10
6	M5 x 0.8	AKH06□-M5	10	25.8	22.2	13.5	2.8	8
		AKH06□-01S		26.9	22.9			
	1/4	AKH06□-02S	14	30	24		17	22
8	1/8	AKH08□-01S	14	31.7	27.7	18.5	6.5	16
		AKH08□-02S		42	36			24
	3/8	AKH08□-03S	17	42	35.5		14	43
10	1/4	AKH10□-02S	17	54.3	48.3	21	24	45
	3/8	AKH10□-03S		47.3	40.8			39
	1/2	AKH10□-04S		22	49.3			41.3
12	3/8	AKH12□-03S	22	60.5	54	22	34	62
	1/2	AKH12□-04S		54.5	46.5			80

* Reference dimension after screwing into R(PT) threads.

Inch Size

Applicable tube O.D.	Connection thread NPT	Model	H (Width across flats)	L	A *	M	Effective area (mm ²)	Weight g
5/32	10-32 UNF	AKH03□-U10/32	8	24.3	21.2	12.7	2.8	5
	1/8	AKH03□-N01S	11.11	24.6	20.6			10
1/4	10-32 UNF	AKH07□-U10/32	11.11	25.8	22.7	13.6	2.8	10
		AKH07□-N01S		26.9	22.9			
	1/4	AKH07□-N02S	14.29	31	25		17	18
5/16	1/8	AKH09□-N01S	14.29	31.7	27.7	18.5	6.5	16
		AKH09□-N02S		42	36			24
	3/8	AKH09□-N03S	17.46	42	35.5		14	43
3/8	1/4	AKH11□-N02S	17.46	54.2	48.3	21	24	47
	3/8	AKH11□-N03S		47.2	40.7			40
	1/2	AKH11□-N04S		22.23	49.2			41.2
1/2	3/8	AKH13□-N03S	22.23	60.5	54	22	34	87
		AKH13□-N04S		54.5	46.5			85

* Reference dimension after screwing into NPT threads.

Check Valve with One-Touch Fitting *Series AKH/AKB*

Dimensions

Bushing Type: AKB

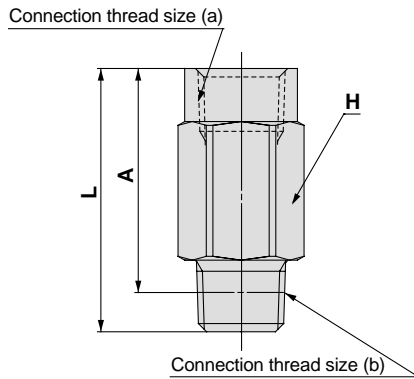

Millimeter Size

Connection thread size R(PT)		Model	H	L	A *	Effective area (mm ²)	Weight g
(a)	(b)						
1/8	1/8	AKB01□-01S	14	23.7	19.7	6.5	18
1/4	1/4	AKB02□-02S	17	39.8	33.8	14	44
3/8	3/8	AKB03□-03S	22	45.2	38.7	24	86
1/2	1/2	AKB04□-04S	24	56.2	48.2	34	113

* Reference dimension after screwing into R(PT) threads.

Inch Size

Connection thread size NPT		Model	H	L	A *	Effective area (mm ²)	Weight g
(a)	(b)						
1/8	1/8	AKB01□-N01S	14.29	24.2	20.2	6.5	18
1/4	1/4	AKB02□-N02S	17.46	40	34	14	44
3/8	3/8	AKB03□-N03S	22.23	44.9	38.4	24	86
1/2	1/2	AKB04□-N04S	23.81	55.5	47.5	34	113

* Reference dimension after screwing into NPT threads.

Series AKH/AKB

Construction

Straight type: AKH

ø4, ø6
ø5/32, ø1/4

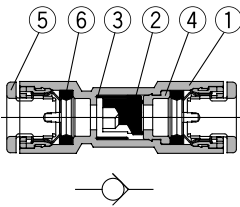

ø8, ø10, ø12
ø5/16, ø3/8, ø1/2

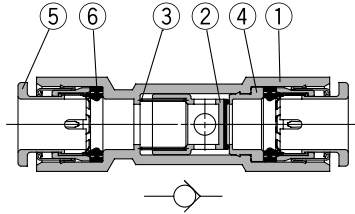

Parts list

No.	Description	Material	Note
1	Body	PBT	
2	Valve	NBR, Aluminum alloy	
3	Spring	Stainless steel	
4	Spacer	Brass	Electroless nickel plated
5	Cassette	-	
6	Seal	NBR	

Male Connector Type: AKH

	M5 type U10/32	ø4, ø6 ø8 x R(PT) 1/8 ø5/32, ø1/4 ø5/16 x NPT 1/8	ø8, ø10, ø12 ø5/16, ø3/8, ø1/2
Free flow Fitting ↑ Male thread			
Free flow Fitting ↓ Male thread			

Parts list

No.	Description	Material	Note
1	Body	Brass	Electroless nickel plated
2	Valve	NBR, Aluminum alloy	
3	Spring	Stainless steel	
4	Spacer	Brass	Electroless nickel plated
5	Stopper	Stainless steel	
6	O-ring	NBR	
7	Cassette	-	
8	Seal	NBR	
9	Gasket	Stainless steel + NBR	

Bushing Type: AKB

	R (PT) 1/8 NPT 1/8	R(PT) 1/4, 3/8, 1/2 NPT1/4, 3/8, 1/2
Free flow Female thread ↑ Male thread		
Free flow Female thread ↓ Male thread		

Parts list

No.	Description	Material	Note
1	Body	Brass	Electroless nickel plated
2	Valve	NBR, Aluminum alloy	
3	Spring	Stainless steel	
4	Spacer	Brass	Electroless nickel plated
5	Stopper	Stainless steel	
6	O-ring	NBR	



Series AKH/AKB Safety Instructions

These safety instructions are intended to prevent a hazardous situation and/or equipment damage. These instructions indicate the level of potential hazard by labels of "Caution", "Warning" or "Danger". To ensure safety, be sure to observe ISO 4414 ^{Note 1)}, JIS B 8370 ^{Note 2)} and other safety practices.

 **Caution** : Operator error could result in injury or equipment damage.

 **Warning** : Operator error could result in serious injury or loss of life.

 **Danger** : In extreme conditions, there is a possible result of serious injury or loss of life.

Note 1) ISO 4414: Pneumatic fluid power – Recommendations for the application of equipment to transmission and control systems.

Note 2) JIS B 8370: Pneumatic system axiom.

Warning

1. The compatibility of pneumatic equipment is the responsibility of the person who designs the pneumatic system or decides its specifications.

Since the products specified here are used in various operating conditions, their compatibility for the specific pneumatic system must be based on specifications or after analysis and/or tests to meet your specific requirements.

2. Only trained personnel should operate pneumatically operated machinery and equipment.

Compressed air can be dangerous if an operator is unfamiliar with it. Assembly, handling or repair of pneumatic systems should be performed by trained and experienced operators.

3. Do not service machinery/equipment or attempt to remove components until safety is confirmed.

1. Inspection and maintenance of machinery/equipment should only be performed after confirmation of safe locked-out control positions.

2. When equipment is to be removed, confirm the safety process as mentioned above. Cut the supply pressure for this equipment and exhaust all residual compressed air in the system.

3. Before machinery/equipment is re-started, take measures to prevent shooting-out of cylinder piston rod, etc. (Bleed air into the system gradually to create back-pressure.)

4. Contact SMC if the product is to be used in any of the following conditions:

1. Conditions and environments beyond the given specifications, or if product is used outdoors.

2. Installation on equipment in conjunction with atomic energy, railway, air navigation, vehicles, medical equipment, food and beverages, recreation equipment, emergency stop circuits, press applications, or safety equipment.

3. An application which has the possibility of having negative effects on people, property, or animals, requiring special safety analysis.



Series AKH/AKB Check Valve Precautions 1

Be sure to read before handling.

Selection

Warning

1. Confirm the specifications.

The products appearing in this catalog are designed for use only in compressed air systems (including vacuum). Do not use outside the specified ranges of pressure, temperature, etc., as this may cause damage or faulty operation. (Refer to specifications.)

Consult with SMC if fluids other than compressed air (including vacuum) are to be used.

Mounting

Warning

1. Read the instruction manual carefully.

The product should be mounted and operated with a good understanding of its contents. Also, keep the manual where it can be easily referred to at any time.

2. Ensure space for maintenance.

Ensure the necessary space for maintenance activities.

3. Strictly observe the fastening of screws and fastening torque.

When mounting, fasten screws with the recommended torque.

Piping

Caution

1. Preparation before piping

Before piping is connected, it should be thoroughly blown out with air (flushing) or washed to remove chips, cutting oil and other debris from inside the pipe.

2. Wrapping of sealing tape

When screwing together pipes and fittings, etc., be certain that chips from the pipe threads and sealing material do not get inside the piping.

Further, when sealing tape is used, leave 1.5 to 2 thread ridges exposed at the end of the threads.

Air Supply

Warning

1. Types of fluid

This product is designed for use with compressed air. Consult with SMC if a different fluid is to be used.

2. When there is a large amount of drainage

Pressurized air containing a large amount of drainage may cause the malfunction of pneumatic equipment. An air dryer or Drain Catch should be installed upstream from filters.

3. Drainage removal

If the air filter drains are not flushed regularly, the drainage will flow downstream and this may lead to the malfunction of pneumatic equipment.

In cases where the management of drain flushing will be difficult, the use of filters with automatic drains is recommended.

For details on the qualities of compressed air mentioned above, refer to SMC's "Compressed Air Cleaning Systems" catalog.

4. Types of air

Do not use compressed air containing chemicals, synthetic oil which includes organic solvents, salt, corrosive gases, etc., as this may cause damage or faulty malfunction.



Series AKH/AKB Check Valve Precautions 2

Be sure to read before handling.

Operating Environment

Warning

1. Do not operate in locations having an atmosphere of corrosive gases, chemicals, sea water, fresh water or water vapor, or where there will be contact with the same.
2. In locations which receive direct sunlight, the sunlight should be blocked .
3. Do not operate in locations where vibration or impact occurs.
4. Do not operate in a location near a heat source where radiated heat will be received.

Maintenance

Warning

1. Maintenance should be performed in accordance with procedures in the instruction manual.

Improper handling may cause damage or malfunction of equipment or machinery.

2. Maintenance operations

Improper handling of compressed air is dangerous. Therefore, in addition to observing the product specifications, replacement of elements and other maintenance activities should be performed by personnel having sufficient knowledge and experience pertaining to pneumatic equipment.

3. Drain flushing

Drainage should be flushed from air filter and other drains on a regular basis. (Refer to specifications.)

4. Pre-maintenance inspection

When removing this product, turn off the electric power, and be certain to shut off the supply pressure and exhaust the compressed air in the system. Proceed only after confirming that all pressure has been released to the atmosphere.

5. Post maintenance inspection

After installation, repair or reconstruction, reconnect compressed air and electric power, and then perform inspections for proper operation and air leakage. If the sound of air leakage can be heard, or if the equipment does not operate properly, stop operation and confirm that it is mounted correctly.

6. Disassembly and alteration prohibited

Do not disassemble the unit or make any alterations to it.



Series AKH/AKB Specific Product Precautions 1

Be sure to read before handling. Refer to pages 6 through 8 for safety instructions and precautions.

Selection

⚠ Warning

1. **Cannot be used as a check valve when zero leakage is required.**

A certain amount of leakage is allowed in the product's specifications.

⚠ Caution

1. **Do not use in a location where connection threads or tube connecting sections will slide or turn.**
2. **Use tubing within its minimum bend radius.**
3. **Do not use for gas, gas fuels and refrigerants, etc., which are combustible, explosive or poisonous.**
4. **Confirm whether PTFE can be used.**

PTFE (tetrafluoroethylene resin) powder is contained in the sealing materials. Confirm that this will not cause operating problems.

Operating Environment

⚠ Warning

1. **Do not use in locations where static electric charges will be a problem.**

This can cause malfunction or failure of the system.

2. **Except for the bushing type: AKB, do not use in locations where spatter is generated.**

There is a danger of fire occurring if spatter sticks to synthetic resin parts.

3. **Except for the bushing type: AKB, do not use in environments where there will be direct contact with liquids such as cutting oil, lubricating oil or coolant oil.**

Contact SMC regarding operation in this kind of environment.

Maintenance

⚠ Caution

1. **Check for the following during regular maintenance, and replace components as necessary.**

- a) Scratches, gouges, abrasion, corrosion
- b) Air leakage
- c) Twisting, flattening or distortion of tubing
- d) Hardening, deterioration or softness of tubing

2. **Do not repair or patch the replaced tubing or fittings for reuse.**

Mounting

⚠ Caution

1. **Confirm the model and size, etc. before mounting.**

Also, confirm that the product has no scratches, gouges or cracks, etc.

2. **Confirm the flow direction of a check valve when mounting.**

Confirm the free flow direction with the JIS symbol which is displayed on the body.

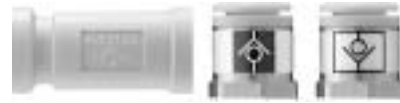

3. **When connecting tubing, make allowances for changes in the length of the tubing, etc. due to pressure.**

4. **Do not allow tubing and fittings to be subjected to distortion, twisting, pulling or moment loads, etc. This can cause damage to fittings, and crushing, bursting or disconnection of tubing, etc.**

5. **Do not allow tubing to be worn, twisted or scratched. This can cause crushing, bursting or disconnection of the tubing, etc.**

6. **When connecting piping and fittings, etc., be careful that chips from the pipe threads and sealing material do not get inside. Also, when sealing tape is used, leave about 2 thread ridges uncovered at the end of the pipe.**

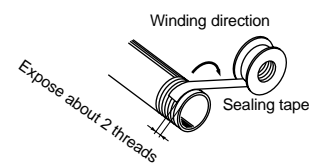

7. **When connecting taper pipe threads, tighten the wrench flats on the body with a suitable wrench.**

Damage can be caused if any other area is used.



Series AKH/AKB Specific Product Precautions 2

Be sure to read before handling. Refer to pages 6 through 8 for safety instructions and precautions.

Precautions on Other Tube Brands

⚠ Caution

1. When using other than SMC brand tubes, confirm that the following specifications are satisfied with respect to the outside diameter tolerance of the tube.

- 1) Nylon tube within ± 0.1 mm
- 2) Soft nylon tube within ± 0.1 mm
- 3) Polyurethane tube within $+0.15$ mm
 within -0.2 mm

Do not use tubes which do not meet these outside diameter tolerances. It may not be possible to connect them, or they may cause other trouble, such as air leakage or the tube pulling out after connection.

Precautions for One-Touch Fittings

⚠ Caution

Attaching and Detaching Tubes to One-Touch Fittings

1. Attaching of tube

- ① Take a tube having no flaws on its periphery and cut it off at a right angle. When cutting the tube, use tube cutters TK-1, 2 or 3. Do not use pinchers, nippers or scissors, etc. The tube might be cut diagonally or flattened, making installation impossible or causing problems such as disconnection of the tube after installation or air leakage. Allow some extra length in the tube.
- ② Grasp the tube and push it in slowly, inserting it securely all the way into the fitting.
- ③ After inserting the tube, pull on it lightly to confirm that it will not come out. If it is not installed securely all the way into the fitting, this can cause problems such as air leakage or the tube pulling out.

2. Detaching of tube

- ① Push in the release bushing sufficiently, and push the collar equally at the same time.
- ② Pull out the tube while holding down the release bushing so that it does not come out. If the release bushing is not pressed down sufficiently, there will be increased bite on the tube and it will become more difficult to pull it out.
- ③ When the removed tube is to be used again, using the chewed portion of the tube as it is can cause problems such as air leakage or difficulty in removing the tube.

Tightening Torque

⚠ Caution

1. The proper torque for connecting pipe fittings is shown in the table below. As a rule, this is equivalent to 2 or 3 turns with a tool after tightening by hand.

Be careful of damage due to over tightening. When using miniature pipe fittings, tighten by an additional 1/4 turn after hand tightening. Further, in cases such as a universal elbow or universal tee which have gaskets in 2 locations, the additional tightening is doubled to 1/2 turn.

Male thread	Proper tightening torque (N·m)
M5 10/32-UNF	1/6 turn after hand tightening
1/8	7 to 9
1/4	12 to 14
3/8	22 to 24
1/2	28 to 30

**Austria**

SMC Pneumatik GmbH (Austria).
Girakstrasse 8, A-2100 Körneuburg
Phone: 02262-62280, Fax: 02262-62285

**Belgium**

SMC Pneumatics N.V./S.A.
Nijverheidsstraat 20, B-2160 Wommelgem
Phone: 03-355-1464, Fax: 03-355-1466

**Czech**

SMC Czech.s.r.o.
Kodanska 46, CZ-100 10 Prague 10
Phone: 02-67154 790, Fax: 02-67154 793

**Denmark**

SMC Pneumatik A/S
Jens Juuls vej 32, DK-8260 Viby J
Phone: 45-70252900, Fax: 45-70252901

**Estonia**

Teknomaa Eesti AS
Mustamäe tee 5, EE-0006 Tallinn, Estonia
Phone: 259530, Fax: 259531

**Finland**

SMC Pneumatikka OY
Veneentekijäntie 7, SF-00210 Helsinki
Phone: 09-681021, Fax: 09-6810233

**France**

SMC Pneumatique, S.A.
1, Boulevard de Strasbourg, Parc Gustave Eiffel
Bussy Saint Georges
F-77607 Marne La Vallée Cedex 3
Phone: 01-6476 1000, Fax: 01-6476 1010

**Germany**

SMC Pneumatik GmbH
Boschring 13-15, D-63329 Egelsbach
Phone: 06103-4020, Fax: 06103-402139

**Greece**

S. Parianopoulos S.A.
9, Konstantinoupoleos Street,
GR-11855 Athens
Phone: 01-3426076, Fax: 01-3455578

**Hungary**

SMC Hungary Kft.
Budafoki ut 107-113, 1117 Budapest
Phone: 01-204 4366, Fax: 01-204 4371

**Ireland**

SMC Pneumatics (Ireland) Ltd.
2002 Citywest Business Campus,
Naas Road, Saggart, Co. Dublin
Phone: 01-403 9000, Fax: 01-464 0500

**Italy**

SMC Italia S.p.A
Via Garibaldi 62, I-20061 Carugate, (Milano)
Phone: 02-92711, Fax: 02-92150394

**Latvia**

Ottensten Latvia SIA
Ciekurkalna Prima Gara Linija 11,
LV-1026 Riga, Latvia
Phone: 371-23-68625, Fax: 371-75-56748

**Lithuania**

UAB Ottensten Lietuva
Savanoriu pr.180, LT-2600 Vilnius, Lithuania
Phone/Fax: 370-2651602

**Netherlands**

SMC Controls BV
De Ruyterkade 120, NL-1011 AB Amsterdam
Phone: 020-5318888, Fax: 020-5318880

**Norway**

SMC Pneumatics (Norway) A/S
Wollsvæien 13 C, granfoss Noeringspark
N-134 Lysaker, Norway
Phone: 22 99 6036, Fax: 22 99 6103

**Poland**

Semac Co., Ltd.
PL-05-075 Wesola k/Warszaway, ul. Wspolna 1A
Phone: 022-6131847, Fax: 022-613-3028

**Portugal**

SMC España (Sucursal Portugal), S.A.
Rua de Engº Ferreira Dias 452, 4100 Porto
Phone: 02-610-89-22, Fax: 02-610-89-36

**Romania**

SMC Romania srl
Vasile Stroescu 19, Sector 2, Bucharest
Phone: 01-210-1354, Fax: 01-210-1680

**Russia**

SMC Pneumatik LLC
Centrako Business Centre 103,
Bolshoy Prospect V.O., 199106 St. Petersburg
Phone: 812-1195131, Fax: 812-1195129

**Slovakia**

SMC Slovakia s.r.o.
Pribinova ul. C. 25, 819 02 Bratislava
Phone: 0-563 3548, Fax: 07-563 3551

**Slovenia**

SMC Slovenia d.o.o.
Grajski trg 15, 8360 Zuzemberk
Phone: 068-88 044 Fax: 068-88 041

**Spain**

SMC España, S.A.
Zuazobidea 14, Pol. Ind. Jundiz,
E-01015 Vitoria
Phone: 945-184 100, Fax: 945-184 124

**Sweden**

SMC Pneumatics Sweden A.B.
Ekhagsvägen 29-31, S-14105 Huddinge
Phone: 08-603 07 00, Fax: 08-603 07 10

**Switzerland**

SMC Pneumatik AG
Dorfstrasse 7, CH-8484 Weisslingen
Phone: 052-396-3131, Fax: 052-396-3191

**Turkey**

Entek Pnömatik San. ve Tic Ltd. Sti.
Perpa Tic. Merkezi Kat: 11 No: 1625,
TR-80270 Okmeydani Istanbul
Phone: 0212-221-1512, Fax: 0212-220-2381

**UK**

SMC Pneumatics (UK) Ltd
Vincent Avenue, Crownhill,
Milton Keynes, MK8 0AN
Phone: 01908-563888 Fax: 01908-561185

OTHER SUBSIDIARIES WORLDWIDE:

ARGENTINA, AUSTRALIA, BOLIVIA, BRASIL, CANADA, CHILE, CHINA, HONG KONG, INDIA, MALAYSIA, MEXICO, NEW ZEALAND, PHILIPPINES, SINGAPORE, SOUTH KOREA, TAIWAN, THAILANDIA, USA, VENEZUELA

For more information, please contact your local SMC Regional Centre

SMC UK Regional Centres**BELFAST**

Tel:01232 778414 Fax:01232 778422
SMC Pneumatics (UK) Ltd
Northern Ireland Regional Centre
Suite 3, Shaftesbury House, Edgewater Road
Belfast
BT3 9JQ

BIRMINGHAM

Tel:01675 467177 Fax:01675 465073
SMC Pneumatics (UK) Ltd
Birmingham Regional Centre
24 The Courtyard, Gorsey Lane, Coleshill
Warwickshire
B46 1JA

BRISTOL

Tel:01179 522155 Fax:01179 522186
SMC Pneumatics (UK) Ltd
Bristol Regional Centre
5 East Gate Office Centre
East Gate Road, Eastville, Bristol
BS5 6XX

SMC UK Distributors

Birmingham
JAMES LISTER
Tel: 0121 5803800
Fax: 0121 5535951

Blackburn
BLACKBURN PNEUMATIC SYSTEMS LTD
Tel: 01254 682232
Fax: 01254 682224

Bristol
APPLIED AUTOMATION
Tel: 0117 9827769
Fax: 0117 9235522

CRAWLEY

Tel:01293 614094 Fax:01293 614135
SMC Pneumatics (UK) Ltd
Crawley Regional Centre
9 Pelham Court, Pelham Place, Broadfield
Crawley
RH11 9AZ

CUMBERNAULD

Tel:01236 781133 Fax:01236 780611
SMC Pneumatics (UK) Ltd
Scottish Regional Centre
1 Carradale Crescent,
Broadwood Business Park, Cumbernauld
Glasgow
G69 9LE

DROITWICH

Tel: 01905 774544 Fax: 01905 797343
SMC Pneumatics (UK) Ltd
Droitwich Regional Centre
Hampton Park, Hampton Lovett
Droitwich, Worcestershire
WR9 0NX

Bury St Edmunds

PNEUMATIC LINES
Tel: 01284 706239
Fax: 01284 761218

Cardiff

WALES FLUID POWER
Tel: 01222 494551
Fax: 01222 481955

IPSWICH

Tel:01473 240040 Fax:01473 747707
SMC Pneumatics (UK) Ltd
Ipswich Regional Centre
Unit 6 & 7, Alpha Business Park
16-18 Whitehouse Road, Ipswich, Suffolk
IP1 5LT

MANCHESTER

Tel:0161 876 7371 Fax:0161 876 7372
SMC Pneumatics (UK) Ltd
Manchester Regional Centre
3 Modwen Road, Waters Edge Business Park
Ordsall Lane, Salford, Manchester
M5 3EZ

MILTON KEYNES

Tel: 01908 265247 Fax: 01908 262705
SMC Pneumatics (UK) Ltd
Vincent Avenue, Crownhill, Milton Keynes
MK8 0AN

East Grinstead

AUTARKY AUTOMATION
Tel: 01342 311388
Fax: 01342 323733

Newton Aycliffe

ONCAD AUTOMATION
Tel: 01325 311599
Fax: 01325 307562

NEWCASTLE

Tel:0191 487 2040 Fax:0191 487 2041
SMC Pneumatics (UK) Ltd
Newcastle Regional Centre
Unit B6, Marquis Court, Marquis Way
Team Valley Trading Estate, Gateshead
Tyne & Wear
NE11 0RU

POOLE

Tel:01202 732233 Fax:01202 737743
SMC Pneumatics (UK) Ltd
Poole Regional Centre
Unit 4, Acorn Business Centre, Ling Road
Poole, Dorset
BH12 4NZ

SHEFFIELD

Tel: 01909 565504 Fax: 01909 569717
SMC Pneumatics (UK) Ltd
Sheffield Regional Centre
Unit 4, North Anston Business Park
Houghton Road, North Anston, Sheffield
S31 7JJ

Plymouth

APPLIED AUTOMATION
Tel: 01752 343300
Fax: 01752 341161

Redditch

MULTI-PNEUMATICS
Tel: 01527 544544
Fax: 01527 544296