

Flame Resistance (Equivalent to UL-94 Standard V-0)

FR One-touch Fittings

Series KR

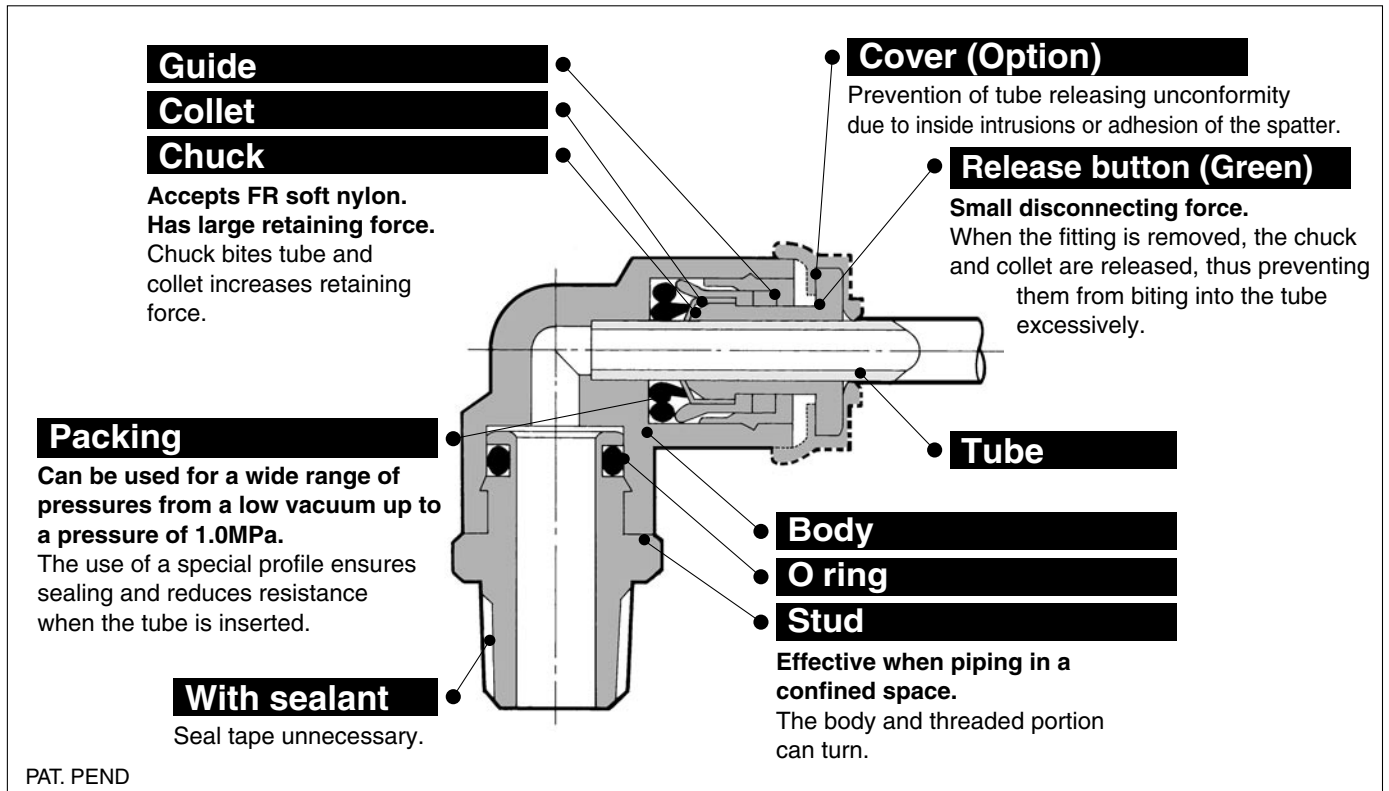

Applicable Tubing

Tube material	FR soft nylon
Tube O.D.	ø6, ø8, ø10, ø12

Specifications

Fluid	Air, Water ⁽¹⁾	
Max. operating pressure	1.0MPa	
Proof pressure	3.0MPa	
Ambient and fluid temperature	-5 to 60°C (Water: 0 to 40°C) (No freezing)	
Thread	Thread portion	JIS B 0203 (Taper pipe thread)
	Nut	JIS B 0211 Class 2 (Metric fine thread)
Sealant (Thread portion)	With sealant (Standard)	

 Note1) Applicable for general industry water. Consult SMC if using for other kind of fluid.
Surge pressure must be under the max. operating pressure.

Component Materials

Body	C3604BD, Flame resistance PBT (UL-94 Standard V-0)
Stud (Thread)	C3604BD
Chuck	Stainless steel (SUS304)
Guide	SUS304, C3604BD, Flame resistance PBT (UL-94 Standard V-0)
Collet	Polyacetal (POM)
Release button	Flame resistance PBT (UL-94 Standard V-0)
Packing, O ring	NBR
Cover (Option)	Flame resistance CR (UL-94 Standard V-0)

Series KR

Model		
Male connector KRH P.7-119		Used to pipe in the same direction from female threaded portion. Most common style.
Union elbow KRL P.7-120		Used to connect tubes at right angles.
Plug-in reducer KRR P.7-122		Used to change size of One-touch fittings.
Straight union KRH P.7-119		Used to connect tubes in the same direction.
Extended male elbow KRW P.7-120		For when the elbow extends over a standard elbow for easier of connection/disconnection of tubing.
Union "Y" KRU P.7-121		Used to connect tubes in the same direction.
Male elbow KRL P.7-120		Used to pipe in right angles to female threaded portion. Most common style.
Branch tee KRT P.7-121		Used to branch line from female thread in both 90° directions.
Plug-in "Y" KRU P.7-121		Used to branch tubing in the same direction from One-touch fittings.
45° male elbow KRK P.7-120		Used in applications where a 45° elbow or male connector stresses the tubing.
Union tee KRT P.7-121		Used to branch connect tubes in both 90° directions.
Branch "Y" KRU P.7-121		Used to branch line in the same direction from female thread.
Universal male union KRV P.7-120		Universal male elbow allows thread connection by using a socket wrench for confined spaces.
Male run tee KRY P.7-121		Used to connect tubes with size down in both 90° directions.
Bulkhead union KRE P.7-122		Used for junction connection of two tubes for installation of a pael.
Spatter cover KR P.7-122		Prevention of tube releasing unconformity due to an inside intrusion or adhesion of the spatter.
Spatter cover KR-□C1 P.7-122		Prevention of tube releasing unconformity due to an inside intrusion or adhesion of the spatter.
Plug KRP P.7-122		Used to shut unused One-touch fittings.

Dimensions

Male connector: KRH

Tube O.D. (mm)	Thread R(PT)	Part No.	H (Hex.)	L	A*	M	Eff. area (mm ²)		Weight (g)
							FR double layer	FR soft nylon	
6	1/8	KRH06-01S	12	21.6	18.5	17	10.4	5.6	16
	1/4	KRH06-02S	14	22.5	17				14
	3/8	KRH06-03S	17	20.9	15.5				27
8	1/8	KRH08-01S	14	27.1	24	18.5	26.1	18.0	21
	1/4	KRH08-02S		26	20.5				19
	3/8	KRH08-03S		17	20.9				15.5
10	1/8	KRH10-01S	17	29.1	26	21	41.5	29.5	19
	1/4	KRH10-02S		33	27.5				30
	3/8	KRH10-03S		27.9	22.5				53
	1/2	KRH10-04S		22	26.1				19
12	1/4	KRH12-02S	19	34	28.5	22	58.3	46.1	42
	3/8	KRH12-03S		28.9	23.5				34
	1/2	KRH12-04S		22	29.1				22

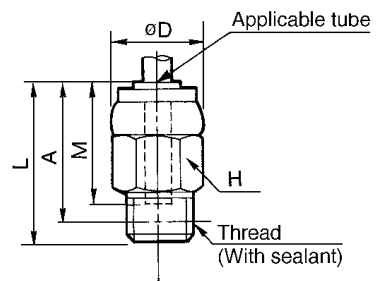

* Reference dimensions after R(PT) thread installation.

Straight union: KRH

Tube O.D. (mm)	Part No.	øD ⁽¹⁾	L	M	Eff. area (mm ²)		Weight (g)
					FR double layer	FR soft nylon	
6	KRH06-00	12.8	34.5	17	10.4	5.6	4
8	KRH08-00	15.2	38.5	18.5	26.1	18.0	6
10	KRH10-00	18.5	42.5	21	41.5	29.5	11
12	KRH12-00	20.9	44.5	22	58.3	46.1	14

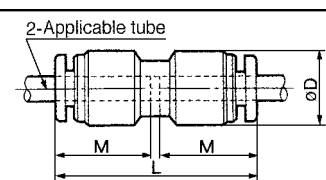

Note1) øD: max. diameter



Male elbow: KRL



Tube O.D. (mm)	Thread R(PT)	Part No.	H (Hex.)	øD ⁽¹⁾	øD ₂	L ₁	L ₂	A*	M	Eff. area (mm ²)		Weight (g)
										FR double layer	FR soft nylon	
6	1/8	KRL06-01S	10	12.8	10	20	22.1	25.5	19	9.0	4.2	12
	1/4	KRL06-02S	14				26.5	27.5				22
	3/8	KRL06-03S	17				27.9	29				33
8	1/8	KRL08-01S	12	15.2	12	23	23.6	28	20.5	21.6	14.9	13
	1/4	KRL08-02S	14				28	30				21
	3/8	KRL08-03S	17				29.4	31.5				35
10	1/8	KRL10-01S	17	18.5	17	26.5	26.1	32	23	21.6	14.9	25
	1/4	KRL10-02S					29.5	33				26
	3/8	KRL10-03S					30.9	34.5				36
	1/2	KRL10-04S					35.1	37				63
12	1/4	KRL12-02S	17	20.9	17	28.5	30.5	35.5	24	50.2	39.7	28
	3/8	KRL12-03S					31.9	37				38
	1/2	KRL12-04S					36.1	39.5				65

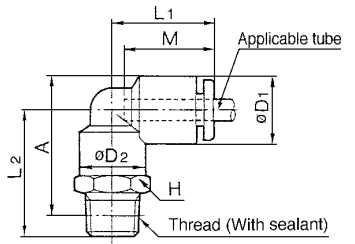

* Reference dimensions after R(PT) thread installation. Note1) øD₁: max. diameter

45° male elbow: KRK



Tube O.D. (mm)	Thread R(PT)	Part No.	H (Hex.)	øD ⁽¹⁾	øD ₂	L ₁	L ₂	A*	M	Eff. area (mm ²)		Weight (g)
										FR double layer	FR soft nylon	
6	1/8	KRK06-01S	10	12.8	10	18	19.6	33	19	6.9	3.4	12
	1/4	KRK06-02S	14				24	35				10
	3/8	KRK06-03S	17				25.4	36.5				33
8	1/8	KRK08-01S	12	15.2	12	20.5	21.1	37	20.5	19.7		13
	1/4	KRK08-02S	14				25.5	39				21
	3/8	KRK08-03S	17				26.9	41				35
10	1/8	KRK10-01S	17	18.5	17	24	23.1	42	23	30.9	23.2	25
	1/4	KRK10-02S					26.5	43.5				26
	3/8	KRK10-03S					27.9	45				36
	1/2	KRK10-04S					32.1	47.5				63
12	1/4	KRK12-02S	17	20.9	17	25	27	45.5	24	44.5	35.1	28
	3/8	KRK12-03S					28.4	47.5				38
	1/2	KRK12-04S					32.6	49.5				65

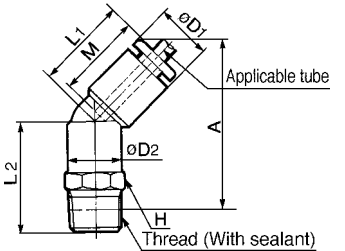

* Reference dimensions after R(PT) thread installation. Note1) øD₁: max. diameter

Universal male elbow: KRV



Tube O.D. (mm)	Thread R(PT)	Part No.	H (Hex.)	øD ⁽¹⁾	øD ₂	L ₁	L ₂	L ₃	A*	M	Eff. area (mm ²)		Weight (g)				
											FR double layer	FR soft nylon					
6	1/8	KRV06-01S	8	12.8	13.4	24	14.5	25.6	22.5	17	5.9	2.9	15				
	1/4	KRV06-02S	10										15.4	23.5	18.5	30.5	25
8	1/8	KRV08-01S	12	15.2	17.6	28.5	15.5	27.6	24.5	18.5	16	11.2	24				
	1/4	KRV08-02S											18.5	31	25.5	30	30
	3/8	KRV08-03S											14	20.6	27.5	20.5	35.4
10	1/4	KRV10-02S	14	18.5	20.6	31	19.5	35	29.5	21	27	20.3	40				
	3/8	KRV10-03S					20.5	35.4	30				49				
12	3/8	KRV12-03S	17	20.9	25.2	34	22	37.4	32	22	39	30.8	63				
	1/2	KRV12-04S					25	40.6	33.5				80				

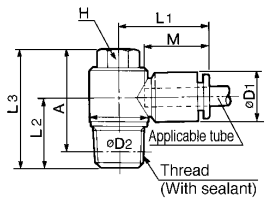

* Reference dimensions after R(PT) thread installation. Note1) øD₁: max. diameter

Union elbow: KRL



Tube O.D. (mm)	Part No.	øD ⁽¹⁾	L	Q	M	Eff. area (mm ²)		Weight (g)
						FR double layer	FR soft nylon	
6	KRL06-00	12.8	20	5.3	17	9.0	4.2	6
8	KRL08-00	15.2	23	6	18	21.6	14.9	10
10	KRL10-00	18.5	26.5	6.8	21	35.2	25.0	17
12	KRL12-00	20.9	28.5	7.5	22	50.2	39.7	21

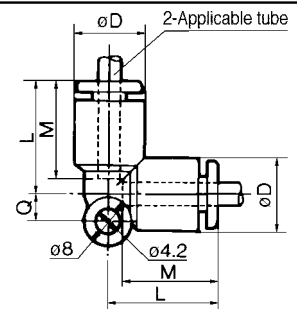

Note1) øD₁: max. diameter

Extended male elbow: KRW



Tube O.D. (mm)	Thread R(PT)	Part No.	H (Hex.)	øD ⁽¹⁾	øD ₂	L ₁	L ₂	A*	M	Eff. area (mm ²)		Weight (g)
										FR double layer	FR soft nylon	
6	1/8	KRW06-01S	10	12.8	10	20	39.1	42.5	17	8.6	4.0	26
	1/4	KRW06-02S	14				45.5	46.5				41
	3/8	KRW06-03S	17				46.9	48				67
8	1/8	KRW08-01S	12	15.2	12	23	42.6	47	18.5	20.5	14.2	30
	1/4	KRW08-02S	14				49	51				47
	3/8	KRW08-03S	17				50.4	52.5				74
10	1/4	KRW10-02S	17	18.5	17	26.5	56	59.5	21	33.5	23.8	66
	3/8	KRW10-03S					57.4	61				76
	1/2	KRW10-04S					64.1	66				145
12	1/4	KRW12-02S	17	20.9	17	28.5	57	62	22	47.7	37.7	68
	3/8	KRW12-03S					58.4	63.5				78
	1/2	KRW12-04S					65.1	68.5				147

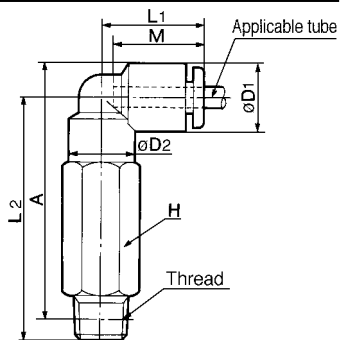

* Reference dimensions after R(PT) thread installation. Note1) øD₁: max. diameter

Series KR

Union tee: KRT



Tube O.D. (mm)	Part No.	øD ⁽¹⁾	L	Q	M	Eff. area (mm ²)		Weight (g)
						FR double layer	FR soft nylon	
6	KRT06-00	12.8	20	5.3	17	10.6	6.4	10
8	KRT08-00	15.2	23	6	18.5	25.6	17.7	15
10	KRT10-00	18.5	26.5	6.8	21	40	28.4	25
12	KRT12-00	20.9	28.5	7.5	22	57.4	45.4	29

Note1) øD1: max. diameter

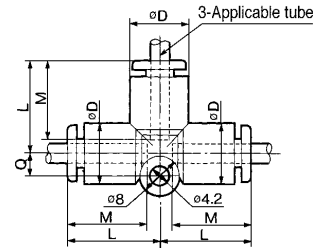

Branch tee: KRT



Tube O.D. (mm)	Thread R(PT)	Part No.	H (Hex.)	øD ⁽¹⁾	øD2	L1	L2	A*	M	Eff. area (mm ²)		Weight (g)
										FR double layer	FR soft nylon	
6	1/8	KRT06-01S	10	12.8	10	20	22.1	25.5	17	11.0	6.0	12
	1/4	KRT06-02S	14				26.5	27.5				20
	3/8	KRT06-03S	17				27.9	29				34
8	1/8	KRT08-01S	12	15.2	12	23	23.6	28	18.5	26.3	18.2	14
	1/4	KRT08-02S	14				28	30				22
	3/8	KRT08-03S	17				29.4	31.5				36
10	1/8	KRT10-01S	12	18.5	17	26.5	26.1	32	21	40.8	29.0	31
	1/4	KRT10-02S	14				29.5	33				29
	3/8	KRT10-03S	17				30.9	34.5				39
12	1/2	KRT10-04S	22	20.9	17	28.5	35.1	37	22	57.2	45.2	66
	1/4	KRT12-02S	17				30.5	35.5				31
	3/8	KRT12-03S	17				31.9	37				41
	1/2	KRT12-04S	22				36.1	39.5				68

* Reference dimensions after R(PT) thread installation. Note1) øD1: max. diameter

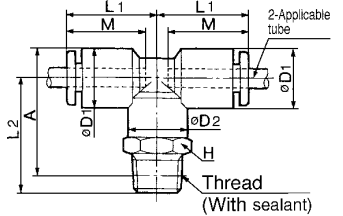

Male run tee: KRY



Tube O.D. (mm)	Thread R(PT)	Part No.	H (Hex.)	øD ⁽¹⁾	øD2	L1	L2	A*	M	Eff. area (mm ²)		Weight (g)
										FR double layer	FR soft nylon	
6	1/8	KRY06-01S	10	12.8	10	20	22.1	39	19	10.6	6.4	12
	1/4	KRY06-02S	14				26.5	41				20
	3/8	KRY06-03S	17				27.9	42.5				34
8	1/8	KRY08-01S	12	15.2	12	23	23.6	43.5	20.5	25.6	17.7	14
	1/4	KRY08-02S	14				28	45.5				22
	3/8	KRY08-03S	17				29.4	47				36
10	1/8	KRY10-01S	12	18.5	17	26.5	26.1	49.5	23	40.0	28.4	31
	1/4	KRY10-02S	14				29.5	50.5				29
	3/8	KRY10-03S	17				30.9	52				39
12	1/2	KRY10-04S	22	20.9	17	28.5	35.1	54.5	24	57.4	45.4	66
	1/4	KRY12-02S	17				30.5	53.5				31
	3/8	KRY12-03S	17				31.9	55				41
	1/2	KRY12-04S	22				36.1	57.5				68

* Reference dimensions after R(PT) thread installation. Note1) øD1: max. diameter

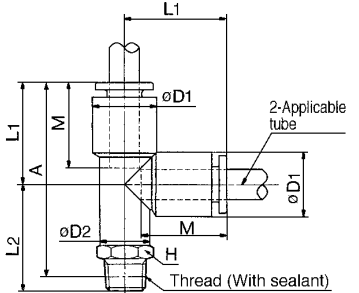

Branch "Y": KRU



Tube O.D. (mm)	Thread R(PT)	Part No.	H (Hex.)	øD ⁽¹⁾	L	P	A*	M	Eff. area (mm ²)		Weight (g)
									FR double layer	FR soft nylon	
6	1/8	KRU06-01S	13	12.8	44.6	12.8	41.5	17	10.4	4.2	12
	1/4	KRU06-02S	14		48.5		43				22
	3/8	KRU06-03S	17		49.9		44.5				35
8	1/8	KRU08-01S	12	15.2	51.6	15.2	48.5	18.5	25.6	17.7	16
	1/4	KRU08-02S	14		55		49.5				24
	3/8	KRU08-03S	17		55.4		50				36
10	1/4	KRU10-02S	14	18.5	60.5	18.5	55	21	40	28.4	30
	3/8	KRU10-03S	17		60.9		55.5				40
	1/2	KRU10-04S	22		64.1		57				65
12	1/4	KRU12-02S	14	20.9	64	20.9	58.5	22	57.4	45.4	32
	3/8	KRU12-03S	17		64.4		59				40
	1/2	KRU12-04S	22		67.6		60.5				65

* Reference dimensions after R(PT) thread installation. Note1) øD1: max. diameter

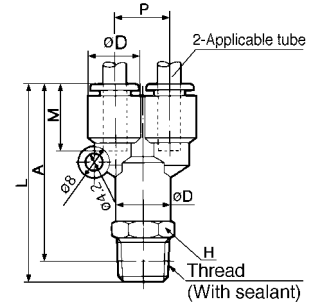

Union "Y": KRU



Tube O.D. (mm)	Part No.	øD ⁽¹⁾	L1	L2	P	Q	M	Eff. area (mm ²)		Weight (g)
								FR double layer	FR soft nylon	
6	KRU06-00	12.8	37	20	12.8	11.7	17	10.4	4.2	10
8	KRU08-00	15.2	42.5	24.5	15.2	13.7	18.5	25.6	17.7	12
10	KRU10-00	18.5	48	27.5	18.5	16.1	21	40	28.4	16
12	KRU12-00	20.9	51	30	20.9	18.1	22	57.4	45.4	23

Note1) øD1: max. diameter

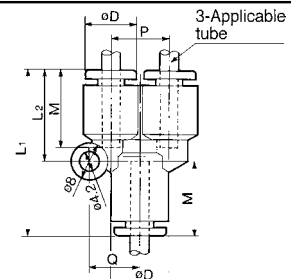

Plug-in "Y": KRU



Tube O.D. (mm)	Thread R(PT)	Part No.	øD ⁽¹⁾	L1	L2	P	Q	A	M	Eff. area (mm ²)		Weight (g)
										FR double layer	FR soft nylon	
6	6	KRU06-99	12.8	55.5	20	12.8	11.7	38.5	17	10.4	4.2	19
8	8	KRU08-99	15.2	64.5	24.5	15.2	13.7	46	18.5	25.6	17.7	22
10	10	KRU10-99	18.5	71.5	27.5	18.5	16.1	50.5	21	40	28.4	26
12	12	KRU12-99	20.9	75.5	30	20.9	18.1	53.5	22	57.4	45.4	32

Note1) øD1: max. diameter

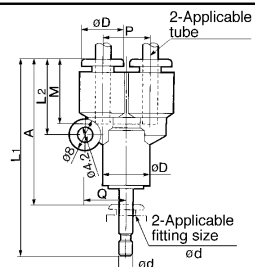

Plug-in reducer: KRR



Tube O.D. (mm)	Fitting size ϕd	Part No.	$\phi D^{(1)}$	L	A	M	Eff. area (mm ²)		Weight (g)
							FR double layer	FR soft nylon	
6	8	KRR06-08	12.8	37	18.5	17	10.4	5.6	2.5
	10	KRR06-10		39.5					9.3
8	10	KRR08-10	15.2	41	18.5	18.5	26.1	18.0	4.0
	12	KRR08-12		42					20
10	12	KRR10-12	18.5	44.5	23	21	41.5	32.8	33

Note1) ϕD_1 : max. diameter

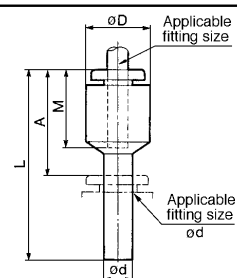

Bulkhead union: KRE



Tube O.D. (mm)	Part No.	T (M)	H (Hex.)	L	Mounting hole	M	Eff. area (mm ²)		Weight (g)
							FR double layer	FR soft nylon	
6	KRE06-00	M14 X 1	17	34.5	15	17	10.4	5.6	33
8	KRE08-00	M16 X 1	19	38	17	18.5	26.1	18.0	52
10	KRE10-00	M20 X 1	24	42.5	21	21	41.5	29.5	70
12	KRE12-00	M22 X 1	27	44	23	22	58.3	46.1	90

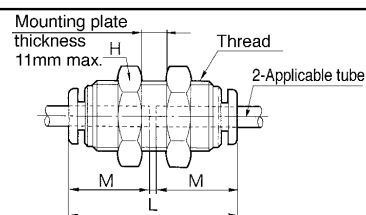

Plug: KRP



Fitting size ϕd	Part No.	ϕD	L	A	Weight (g)
6	KRP-06	8	35	16	1
8	KRP-08	10	39	18.5	2
10	KRP-10	12	43	20	3.5
12	KRP-12	14	46	22	5

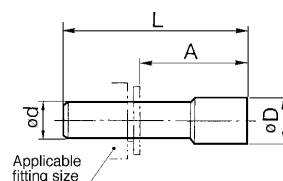

Spatter Cover 1: KR (Applicable tube: FR soft nylon)



Fitting size	Part No.	ϕD	L	Weight (g)
6	KR-06C	15.5	9	0.9
8	KR-08C	17	9	1.0
10	KR-10C	20.8	10.5	1.5
12	KR-12C	22.8	10.5	1.6

* When tube insert parts are in line as KQU Union "Y", use KR-□□C1.

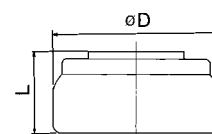

Spatter Cover 2: KR (Applicable tube: FR soft nylon, FR double layer)



Fitting size	Part No.	L ₁	L ₂	ϕD
6	KR-06C1	18	13.7	12.8
8	KR-08C1	20	15.7	15
10	KR-10C1	22	17.2	18
12	KR-12C1	22	17.2	20

Installed

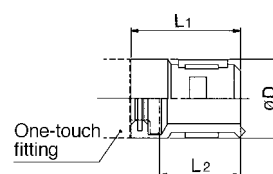

How to install

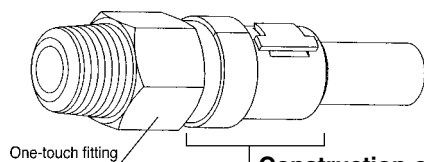

Construction of spatter cover

