















Prese ad Innesto Rapido - Quick Couplings - Schnellverschluss Kupplungen - Coupleurs Automatiques - Enchufes Rápidos - Conexões de Engate Rápido

<p>SERIE UNI ISO 6150 A-6</p>  <p>Serie 100 Pag. 15.7 - 15.10</p>	<p>SERIE MIGNON New</p>  <p>Serie 110 Pag. 15.11 - 15.16</p>	<p>SERIE UNI ISO 6150 B-12</p>  <p>Serie 120 Pag. 15.17 - 15.22</p>	<p>ITALIAN PROFILE</p>  <p>Serie 120 Pag. 15.23 - 15.28</p>
<p>SERIE UNI ISO 6150 B-15</p>  <p>Serie 130 Pag. 15.29 - 15.33</p>	<p>SERIE UNI ISO 6150 C-10</p>  <p>Serie 140 Pag. 15.34 - 15.39</p>	<p>EUROPEAN PROFILE</p>  <p>Serie 160 Pag. 15.40 - 15.45</p>	<p>SWISS PROFILE</p>  <p>Serie 170 Pag. 15.46 - 15.50</p>
<p>MIGNON PROFILE New</p>  <p>Serie 180 Pag. 15.51 - 15.54</p>	<p>MULTISOCKET New</p>  <p>Serie 190 - 63190 Pag. 15.55 - 15.61</p>	<p>JAPANESE PROFILE</p>  <p>Serie 400 Pag. 15.62 - 15.64</p>	<p>MINI DN 2,7</p>  <p>Serie 700 Pag. 15.65 - 15.67</p>
<p>SERIE UNI ISO 6150 B-17</p>  <p>Serie 710 Pag. 15.68 - 15.70</p>	<p>B-SOCKET EUROPEAN</p>  <p>Serie 720 Pag. 15.71 - 15.74</p>	<p>EUROPEAN PROFILE New</p>  <p>Serie 730 Pag. 15.75 - 15.80</p>	<p>EUROPEAN PROFILE New</p>  <p>Serie 740 Pag. 15.81 - 15.83</p>

Prese di Sicurezza ad Innesto Rapido - Safety Quick Couplings - Kupplungen Sicherheit - Coupleurs de Sécurité - Enchufes de Seguridad - Conexões de Segurança

<p>SERIE UNI ISO 6150 B-12</p>  <p>Serie 620 Pag. 15.85 - 15.88</p>	<p>ITALIAN PROFILE</p>  <p>Serie 650 Pag. 15.89 - 15.90</p>	<p>EUROPEAN PROFILE</p>  <p>Serie 660 Pag. 15.91 - 15.92</p>	<p>SWISS PROFILE</p>  <p>Serie 670 Pag. 15.93 - 15.94</p>
<p>SERIE UNI ISO 6150 B-12</p>  <p>Serie 0B120 Pag. 15.97 - 15.99</p>	<p>SERIE UNI ISO 6150 C-10</p>  <p>Serie 0B140 Pag. 15.100 - 15.102</p>		

Giunti ad Innesto Rapido per Raffreddamento Stampi - Quick Couplings for Molding Cooling - Schnellkupplungen für Spritzgussanwendungen - Coupleurs pour Moules D'injection - Enchufes Rápidos para Refrigeración de Moldes - Conexões de Engate Rápido para Resfriamento de Moldes

<p>FRENCH PROFILE DN 8 - DN 12</p>  <p>Series 410 - 420 - 510 - 520 Pag. 15.104 - 15.110</p>	<p>INTERNATIONAL PROFILE DN 6 - DN 9</p>  <p>Series 430 - 440 - 530 - 540 Pag. 15.112 - 15.119</p>	<p>EUROPEAN PROFILE DN 6 - DN 9</p>  <p>Series 460 - 470 - 560 - 570 Pag. 15.120 - 15.127</p>	<p>6049 Pag. 15.128</p> 
--	--	--	--

Pistole di Soffiaggio - Blow Guns - Blaspistolen - Soufflettes - Pistolas Sopladoras - Pistola de Ar

 <p>Series 360 Pag. 15.130 - 15.132</p>	 <p>Series 300 Pag. 15.133 - 15.135</p>	 <p>Spare Parts Pag. 15.136</p>	 <p>Series 340 Pag. 15.137</p>
---	---	--	--

Aligned si riserva il diritto di variare modelli e ingombri senza preavviso - Aligned reserves the right to vary models and dimensions without notice - Aligned behält sich das Recht vor, Daten ohne Ankündigung zu ändern
 Aligned se reserva el derecho de modificar modelos y dimensiones sin previo aviso - Aligned se reserva o direito de alterar os modelos e dimensões sem prévio aviso

GIUNTI AD INNESTO RAPIDO E PISTOLE AD ARIA

AUTOMATIC QUICK COUPLINGS AND BLOW GUNS

SCHNELLVERSCHLUSS-KUPPLUNGEN UND BLASPISTOLEN

COUPLEURS AUTOMATIQUES ET SOUFFLETTES

ENCHUFES RÁPIDOS Y PISTOLAS DE AIRE

CONEXÕES DE ENGATE RÁPIDO E PISTOLAS DE AR



Serie Quick Couplings

SERIE 180 MIGNON PROFILE

GIUNTI AD INNESTO RAPIDO A DOPPIA TENUTA
 AUTOMATIC QUICK COUPLINGS WITH DOUBLE SHUT-OFF
 KUPPLUNGEN MIT BEIDSEITIGER ABSPERRUNG
 COUPLEURS À DOUBLE OBTURATIONS
 ENCHUFES RÁPIDOS DE DOBLE OBTURACIÓN
 ENGATE RÁPIDO COM DUPLA RETENÇÃO



CARATTERISTICHE TECNICHE

TECHNICAL CHARACTERISTICS
 TECHNISCHE ANGABEN
 CARACTÉRISTIQUES TECHNIQUES
 CARACTERÍSTICAS TÉCNICAS
 CARACTERÍSTICAS TÉCNICAS



Norma di Riferimento

Reference standard
 Entspricht der Norm
 Norme de référence
 Normativa de referencia
 Norma de referência

1907/2006
 REACH ✓

2011/65/CE
 RoHS ✓

PED
 2014/68/UE

SILICON
 FREE

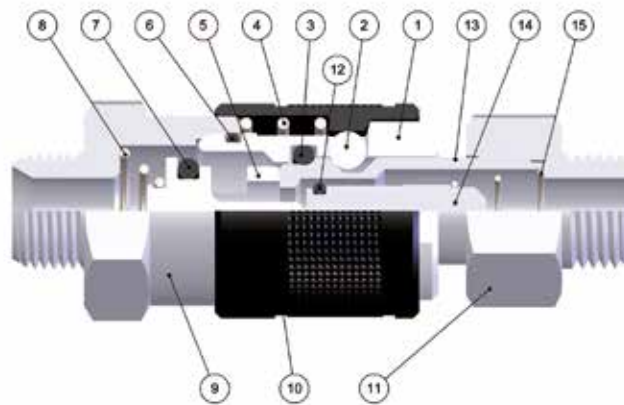

FKM A RICHIESTA
 IF REQUESTED FKM
 FKM AUF ANFRAGE
 FKM SUR DEMANDE
 FKM BAJO DEMANDA
 FKM SOB ENCOMENDA

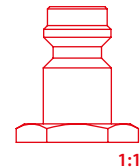
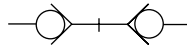

Materiali e Componenti	IT	Component Parts and Materials	GB	Komponenten und Materialien	DE
1 Corpo in Ottone Nichelato		1 Nickel-Plated Brass Body		1 Körper Messing Vernickelt	
2 Sfera in Acciaio AISI 420		2 Stainless Steel AISI 420 Balls		2 Kugel Edelstahl AISI 420	
3 Guarnizione O-Ring in NBR		3 NBR O-Ring Seals		3 O-Ring NBR	
4 Molla Ghiera in Acciaio AISI 302		4 Stainless Steel AISI 302 Ring Nut Spring		4 Entriegelungsfeder Edelstahl AISI 302	
5 Otturatore in Ottone		5 Brass Shutter		5 Verschluss Messing	
6 Guarnizione O-Ring in NBR		6 NBR O-Ring Seals		6 O-Ring NBR	
7 Guarnizione O-Ring in NBR		7 NBR O-Ring Seals		7 O-Ring NBR	
8 Molla Otturatore in Acciaio AISI 302		8 Stainless Steel AISI 302 Shutter Spring		8 Verschlussfeder Edelstahl AISI 302	
9 Attacco Terminale in Ottone Nichelato		9 Nickel-Plated Brass Coupling Back Part		9 Einschraubkörper Messing Vernickelt	
10 Ghiera in Ottone Zincato Nero		10 Black Zinc Plated Brass Sleeve		10 Entriegelungshülse Messing Schwarze Zink	
11 Innesto in Ottone Nichelato		11 Nickel-Plated Brass Plug Outline		11 Stecker Messing Vernickelt	
12 Guarnizione O-Ring Otturatore Innesto in NBR		12 NBR Plug Shutter O-Ring Seals		12 O-Ring NBR	
13 Profilo Innesto in Ottone Nichelato		13 Nickel-Plated Brass Profile Plug		13 Stecker Messing Vernickelt	
14 Otturatore Innesto in Ottone Nichelato		14 Nickel-Plated Brass Plug Shutter		14 Verschluss Messing Vernickelt	
15 Molla Otturatore Innesto in Acciaio AISI 302		15 Stainless Steel AISI 302 Plug Shutter Spring		15 Verschlussfeder Edelstahl AISI 302	

Matériaux et Composants	FR	Materiales y Componentes	ES	Materialis e Componentes	PT
1 Corps: Laiton Nickelé		1 Cuerpo en latón niquelado		1 Corpo em latão niquelado	
2 Bille: Acier Inoxydable AISI 420		2 Esfera en acero AISI 420		2 Esfera em aço AISI 420	
3 Joint Torique en NBR		3 Junta tórica en NBR		3 Vedação O-Ring em NBR	
4 Ressort de Bague: Acier Inoxydable AISI 302		4 Muelle tuerca en acero AISI 302		4 Mola da porca em aço AISI 302	
5 Clapet en Laiton		5 Obturador en latón		5 Obturador em latão	
6 Joint Torique en NBR		6 Junta tórica en NBR		6 Vedação O-Ring em NBR	
7 Joint Torique en NBR		7 Junta tórica en NBR		7 Vedação O-Ring em NBR	
8 Ressort de Clapet: Acier Inoxydable AISI 302		8 Muelle obturador en acero AISI 302		8 Mola do obturador em aço AISI 302	
9 Corps: Laiton Nickelé		9 Conexión terminal en latón niquelado		9 Conexão terminal em latão niquelado	
10 Bague: Laiton Zinc Noir		10 Tuerca en latón Zinc Negro		10 Porca em latão zinco preto	
11 Embout: Laiton Nickelé		11 Enchufe en latón niquelado		11 Plug em latão niquelado	
12 Joint Torique en NBR		12 Junta tórica en NBR		12 Vedação O-Ring em NBR	
13 Embout: Laiton Nickelé		13 Perfil enchufe en latón niquelado		13 Perfil plug em latão niquelado	
14 Clapet en Laiton Nickelé		14 Obturador enchufe en latón niquelado		14 Obturador plug em latão niquelado	
15 Ressort de Clapet: Acier Inoxydable AISI 302		15 Muelle obturador en acero AISI 302		15 Mola do obturador em aço AISI 302	



Pressione d'esercizio

Working Pressures

Betriebsdruck

Pression de service

Presión de Ejercicio

Pressão de Trabalho

0 bar
12 bar



Max pressione statica (no pulsazioni)

Maximum static pressure (no pulsations)

Maximaler statischer Betriebsdruck (ohne pulsations)

Pression statique maximale (sans pulsation)

Presión estática máxima (sin pulsaciones)

Pressão estática máxima (sem pulsações)

35 bar



Temperature

Temperatures

Temperatur

Températures

Temperaturas

Temperaturas

- 20 °C
+ 80 °C

Con O-ring in FKM

With FKM O-ring

Mit O-ring in FKM

Avec joints en FKM

Con junta tórica en FKM

Com O-ring em FKM

- 10 °C
+ 200 °C



Fluidi compatibili

Aria compressa

Fluids

Compressed air

Geeignete Medien

Druckluft

Fluides compatibles

Air comprimé

Fluidos compatibles

Aire comprimido

Fluidos compatíveis

Ar comprimido

Per altri fluidi, consultare l'ufficio tecnico Aignep.

For other fluids, consult the technical department Aignep.

Für andere Flüssigkeiten, kontaktieren Sie uns.

Pour d'autres fluides, veuillez nous consulter.

Para otros fluidos póngase en contacto con el departamento técnico Aignep.

Para outros fluidos consulte o departamento técnico da Aignep.



Portata

NI/min

Flow Rate

Durchflusswerte

Débit

Caudal de Flujo

Vazão

6 bar Δ 1	6 bar Δ 0.5	6 bar *
285	240	445

* Scarico libero - Exhaust Free - Kostenlose Auspuff - Échappement libre - Escape Libre - Descarga libre.



Filettatura

IT

Gas cilindrica conforme ISO 228 Classe A.

Threads

GB

Parallel gas in conformity with ISO 228 Class A.

Gewindearten

DE

Zylindrisches Gewinde nach Norm ISO 228 Classe A.

Filetages

FR

Filetage cylindrique conforme: ISO 228 Classe A.

Roscas

ES

Gas cilíndrica conforme ISO 228 Clase A.

Roscas

PT

Gas paralela conforme ISO 228 Classe A.

181

New

PRESA MASCHIO PER INNESTI OTTURATI

MALE SOCKET FOR SHUTTER PLUG
 VERSCHLUSS-KUPPLUNG MIT AUSSENGEWINDE FÜR STECKER ABSPERREND
 COUPLEUR MÂLE AVEC OBTURATION
 ENCHUFE MACHO PARA ADAPTADOR OBTURADO
 SOQUETE COM ROSCA MACHO PARA PLUG COM RETENÇÃO

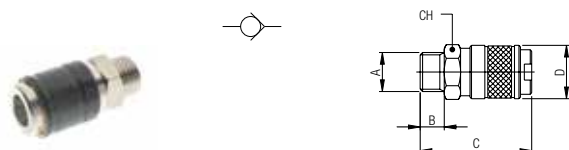

Code	A	B	C	D	CH	Pack.
00181 00 001	1/8	6	35.5	18	16	10
00181 00 002	1/4	8	37.5	18	16	10
00181 00 003	3/8	9	38.5	18	19	10
Code FKM						
00181 00 004	1/8	6	35.5	18	16	10
00181 00 005	1/4	8	37.5	18	16	10
00181 00 006	3/8	9	38.5	18	19	10

182

New

PRESA FEMMINA PER INNESTI OTTURATI

FEMALE SOCKET FOR SHUTTER PLUG
 VERSCHLUSS-KUPPLUNG MIT INNENGEWINDE FÜR STECKER ABSPERREND
 COUPLEUR FEMELLE AVEC OBTURATION
 ENCHUFE HEMBRA PARA ADAPTADOR OBTURADO
 SOQUETE COM ROSCA FÊMEA PARA PLUG COM RETENÇÃO

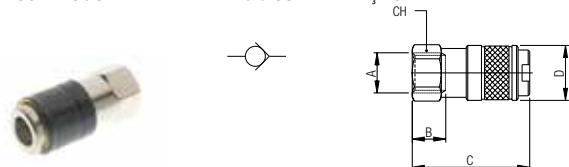

Code	A	B	C	D	CH	Pack.
00182 00 001	1/8	7.5	35	18	16	10
00182 00 002	1/4	11	38.5	18	16	10
00182 00 003	3/8	11.5	39	18	19	10
Code FKM						
00182 00 004	1/8	7.5	35	18	16	10
00182 00 005	1/4	11	38.5	18	16	10
00182 00 006	3/8	11.5	39	18	19	10

183

PRESA A CALZAMENTO CON MOLLA PER INNESTI OTTURATI

COMPRESSION SOCKET WITH NUT AND SPRING FOR SHUTTER PLUG
 VERSCHLUSS-KUPPLUNG SCHOTTVERSION MIT KNICKSCHUTZFEDER FÜR STECKER ABSPERREND
 COUPLEUR À COIFFE AVEC OBTURATION
 ENCHUFE TUBO CON MUELLE PARA ADAPTADOR OBTURADO
 SOQUETE COM CONEXÃO PUSH-ON COM MOLA PARA PLUG COM RETENÇÃO

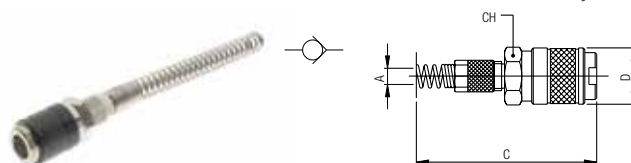

Code	A	C	D	CH	Pack.
00183 00 001	6/4	124	18	16	10
00183 00 002	8/6	129.5	18	16	10

Molla Acciaio Inox AISI 304 - EN 1.4301
 Stainless Steel Spring AISI 304 - EN 1.4301
 Edelstahlfeder AISI 304 - EN 1.4301
 Ressort Acier Inoxydable AISI 304 - EN 1.4301
 Muelle Acero Inoxidable AISI 304 - EN 1.4301
 Mola Aço Inoxidável AISI 304 - EN 1.4301

184

PRESA A CALZAMENTO PER INNESTI OTTURATI

COMPRESSION SOCKET FOR SHUTTER PLUG
 VERSCHLUSS-KUPPLUNG MIT ÜBERWURFVERSCHRAUBUNG FÜR STECKER ABSPERREND
 COUPLEUR À COIFFE AVEC OBTURATION
 ENCHUFE TUBO PARA ADAPTADOR OBTURADO
 SOQUETE COM CONEXÃO PUSH-ON PARA PLUG COM RETENÇÃO

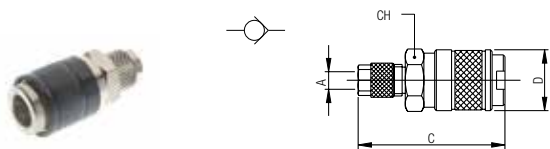

Code	A	C	D	CH	Pack.
00184 00 001	6/4	42	18	16	10
00184 00 002	8/6	42	18	16	10

185

PRESA CON PORTAGOMMA A RESCA PER INNESTI OTTURATI

BARBED SOCKET FOR SHUTTER PLUG
 VERSCHLUSS-KUPPLUNG MIT SCHLAUCHTÜLLE BEIDSEITIG ABSPERREND
 COUPLEUR À DOUILLE ANNELÉE AVEC OBTURATION
 ENCHUFE ESPIGA PARA ADAPTADOR OBTURADO
 SOQUETE COM ESPIGAO PARA TUBO DE BORRACHA PARA PLUG COM RETENÇÃO

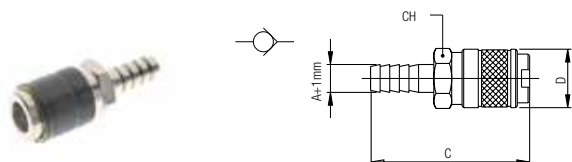

Code	A	C	D	CH	Pack.
00185 00 001	4	48	18	16	10
00185 00 002	6	48	18	16	10
00185 00 003	8	48	18	16	10

281

INNESTO OTTURATO MASCHIO

MALE SHUTTER PLUG
 STECKER ABSPERREND MIT AUSSENGEWINDE
 EMBOUT MÂLE, DOUBLE OBTURATIONS
 ADAPTADOR OBTURADO MACHO
 PLUG COM RETENÇÃO E ROSCA MACHO

New

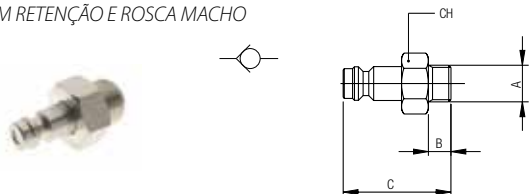

Code	A	B	C	CH	Pack.
00281 00 001	1/8	6	29.5	14	10
00281 00 002	1/4	8	31.5	17	10
00281 00 003	3/8	9	32.5	19	10

Code FKM	A	B	C	CH	Pack.
00281 00 004	1/8	6	29.5	14	10
00281 00 005	1/4	8	31.5	17	10
00281 00 006	3/8	9	32.5	19	10

Utilizzare solo con prese per innesti otturati.
 Using only with socket for shutter plug.
 Nur Mit Verschluss-Kupplungen Beidseitig Absperrend Einsetzbar.
 Utilisable avec pleurico à obturation.
 Utilizar solo con enchufes para adaptador obturado.
 Utilizar somente com soquete para plug com retenção.

282

INNESTO OTTURATO FEMMINA

FEMALE SHUTTER PLUG
 STECKER ABSPERREND MIT INNENGEWINDE
 EMBOUT FEMELLE, DOUBLE OBTURATIONS
 ADAPTADOR OBTURADO HEMBRA
 PLUG COM RETENÇÃO E ROSCA FÊMEA

New

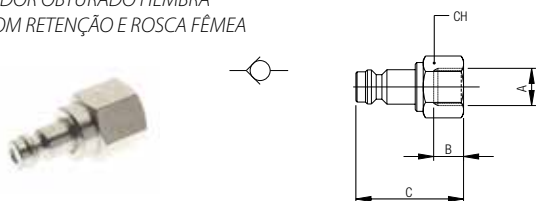

Code	A	B	C	CH	Pack.
00282 00 001	1/8	7.5	31.5	14	10
00282 00 002	1/4	11	35	17	10
00282 00 003	3/8	11.5	35.5	19	10

Code FKM	A	B	C	CH	Pack.
00282 00 004	1/8	7.5	31.5	14	10
00282 00 005	1/4	11	35	17	10
00282 00 006	3/8	11.5	35.5	19	10

Utilizzare solo con prese per innesti otturati.
 Using only with socket for shutter plug.
 Nur Mit Verschluss-Kupplungen Beidseitig Absperrend Einsetzbar.
 Utilisable avec pleurico à obturation.
 Utilizar solo con enchufes para adaptador obturado.
 Utilizar somente com soquete para plug com retenção.

283

INNESTO OTTURATO A CALZAMENTO CON MOLLA

COMPRESSION SHUTTER PLUG WITH NUT AND SPRING
 STECKER ABSPERREND MIT KNICKSCHUTZFEDER
 EMBOUT AVEC RESSORT DE PROTECTION, DOUBLE OBTURATIONS
 ADAPTADOR OBTURADO TUBO CON MUELLE
 PLUG COM RETENÇÃO E CONEXÃO PUSH-ON COM MOLLA



Code	A	C	CH	Pack.
00283 00 001	6/4	118.5	12	10
00283 00 002	8/6	122	12	10

Utilizzare solo con prese per innesti otturati.
 Using only with socket for shutter plug.
 Nur Mit Verschluss-Kupplungen Beidseitig Absperrend Einsetzbar.
 Utilisable avec pleurico à obturation.
 Utilizar solo con enchufes para adaptador obturado.
 Utilizar somente com soquete para plug com retenção.

Molla Acciaio Inox AISI 304 - EN 1.4301
 Stainless Steel Spring AISI 304 - EN 1.4301
 Edelstahlfeder AISI 304 - EN 1.4301
 Ressort Acier Inoxydable AISI 304 - EN 1.4301
 Muelle Acero Inoxidable AISI 304 - EN 1.4301
 Mola Aço Inoxidável AISI 304 - EN 1.4301

284

INNESTO OTTURATO A CALZAMENTO

COMPRESSION SHUTTER PLUG
 STECKER ABSPERREND MIT ÜBERWURFVERSCHRAUBUNG
 EMBOUT À RACCORD À COIFFE, DOUBLE OBTURATION
 ADAPTADOR OBTURADO TUBO
 PLUG COM RETENÇÃO E CONEXÃO PUSH-ON

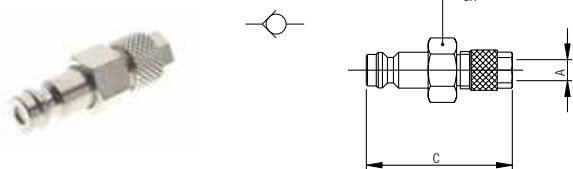

Code	A	C	CH	Pack.
00284 00 001	6/4	36.5	12	10
00284 00 002	8/6	36.5	12	10

Utilizzare solo con prese per innesti otturati.
 Using only with socket for shutter plug.
 Nur Mit Verschluss-Kupplungen Beidseitig Absperrend Einsetzbar.
 Utilisable avec pleurico à obturation.
 Utilizar solo con enchufes para adaptador obturado.
 Utilizar somente com soquete para plug com retenção.

285

INNESTO OTTURATO PORTAGOMMA A RESCA

SHUTTER BARBED PLUG
 STECKER ABSPERREND MIT SCHLAUCHTÜLLE
 EMBOUT À DOUILLE ANNELÉE, DOUBLE OBTURATIONS
 ADAPTADOR OBTURADO ESPIGA
 PLUG COM RETENÇÃO E ESPIGÃO PARA TUBO DE BORRACHA



Code	A	C	CH	Pack.
00285 00 001	4	43.5	11	10
00285 00 002	6	43.5	11	10
00285 00 003	8	43.5	13	10

Utilizzare solo con prese per innesti otturati.
 Using only with socket for shutter plug.
 Nur Mit Verschluss-Kupplungen Beidseitig Absperrend Einsetzbar.
 Utilisable avec pleurico à obturation.
 Utilizar solo con enchufes para adaptador obturado.
 Utilizar somente com soquete para plug com retenção.