

Stainless One-touch Fittings

Series KG

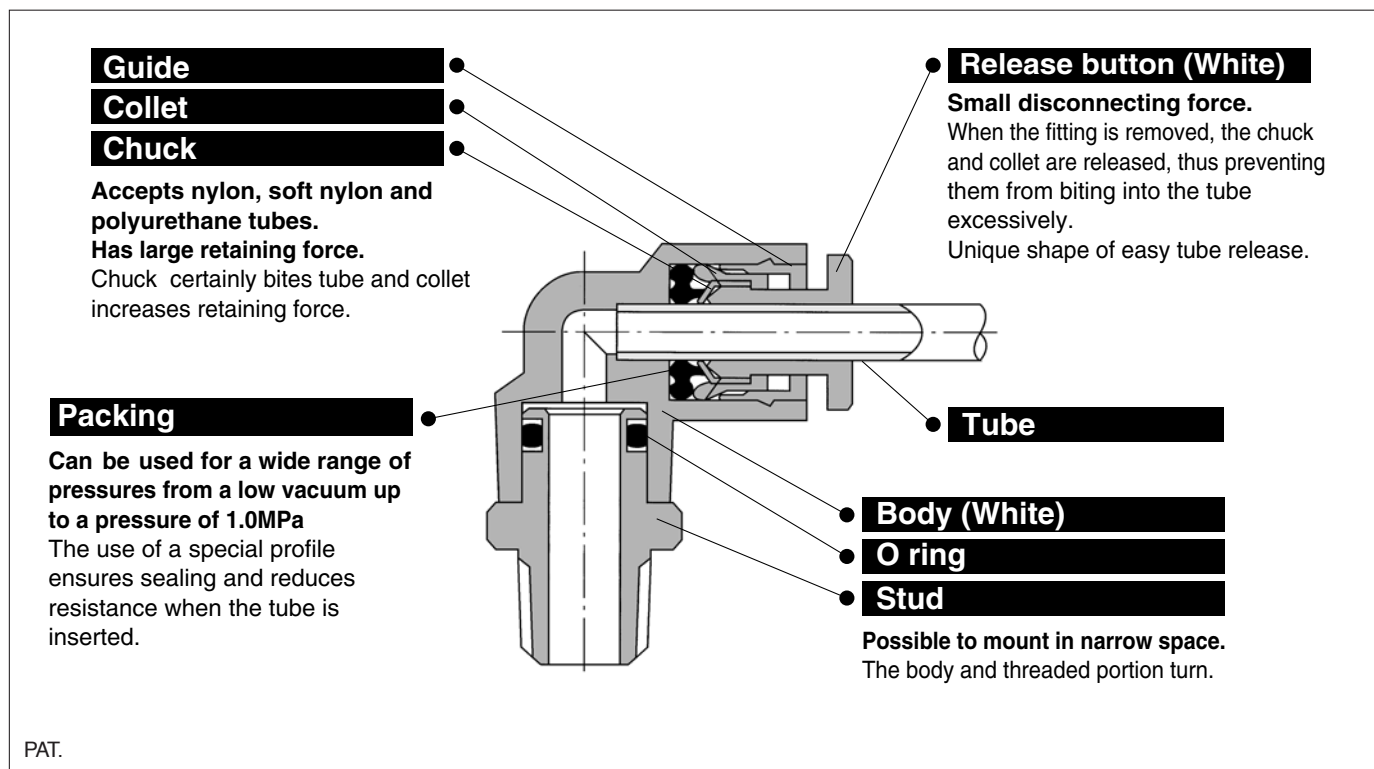

Stainless specification applicable to corrosive environments

SUS 303 stainless steel adopted for metal elements

Suitable for use in CRT production lines where contact with copper must be avoided, food processing machines where water or salt water splashes and clean room where discolouration of copper material and corrosion must be avoided.



Applicable Tubing

Tube material	Nylon, Soft nylon, Polyurethane
Tube O.D.	ø4, ø6, ø8, ø10, ø12, ø16

Specifications

Operating fluid		Air, Water ⁽¹⁾
Max. operating pressure		1.0MPa
Max. operating vacuum pressure		-100kPa
Proof pressure		3.0MPa
Ambient and fluid temperature		-5 to 60°C (Water: 0 to 40°C)(No freezing)
Thread	Thread portion	JIS B 0203 (Taper pipe thread)
	Nut	JIS B 0211 Class 2 (Metric fine thread)
Sealant (Thread portion)		With/Without sealant ⁽²⁾

 Note1) Applicable for general industry water. Consult us if using for other kinds of fluid. Surge pressure must be under the max. operating pressure.
Note2) Suffix "S" to part number if sealant is desired.

Component Materials

Body	Stainless steel (SUS303), PBT
Stud (Thread)	Stainless steel (SUS303)
Chuck	Stainless steel (SUS304)
Guide	SUS304, Stainless steel (SUS303), POM
Collet, Release button	POM
Packing, O ring	NBR

Stainless One-touch Fittings *Series KG*

Model

Hexagon socket head male connector

KGS P.7-127



Internal hex. allows thread connection by using an hex. key wrench, for confined spaces.

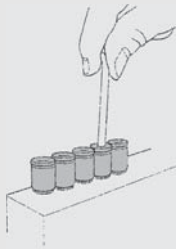

Bulkhead union

KGE P.7-135



Used for junction connection of two tubes for installation of a panel.

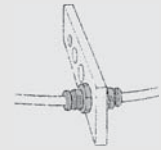

Universal male elbow

KGV P.7-129

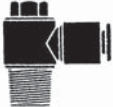

Universal male elbow allows thread connection by using a socket wrench for confined spaces.

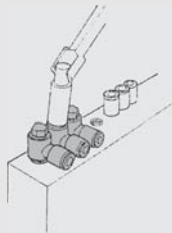

Extended male elbow

KGW P.7-131



For when the elbow extends over a standard elbow for easier of connection/disconnection of tubing.

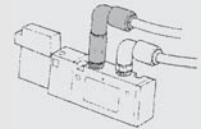

Bulkhead connector

KGE P.7-135



Used for transit connection of a tube and a male screw for installation of a panel.

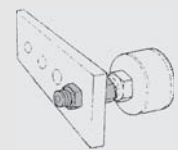

Male connector

KGH P.7-127



Used to pipe in the same direction from female threaded portion. Most common style.

Male elbow

KGL P.7-128



Used to pipe in right angle to female threaded portion. Most common style.

Branch tee

KGT P.7-131



Used to branch line from female thread in both 90° directions.

Female connector

KGF P.7-128



Used to pipe from the male threaded portion such as a pressure gage.

Union elbow

KGL P.7-130



Used to connect tubes at right angles.

Union tee

KGT P.7-131



Used to connect tubes in both 90° directions.

Straight union

KGH P.7-128



Used to connect tubes in the same direction.

Plug-in elbow

KGL P.7-130



Used to change by 90° in a tube fetching direction from One-touch fittings.

Different dia. tee

KGT P.7-132



Used to connect tubes with size down in both 90° directions.

Different dia. straight

KGH P.7-128



Used to connect different size tubes.

Male delta

KGD P.7-132



Used for two branch piping at right angles from female thread.

Male run tee

KGY P.7-132



Used for a branch line in the same direction from female thread and in 90° directions.

Male branch connector

KGLU P.7-129

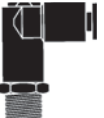

Used for connection at right angles from the female thread.

Delta

KGD P.7-133



Used for three branch connections of tubes at right angles.

Different dia. double union "Y"

KGUD P.7-134



Used for four branch connections in the same direction, reducing the size of the tubes.

Branch union elbow

KGLU P.7-130



Used for connection of tubes at right angles.

Double branch

KGUD P.7-133



Used for four branch piping in the same direction from the female thread.

Union "Y"

KGU P.7-134



Used to connect tubes in the same direction.

Model

Different dia. union "Y"

KGU P.7-134



Used to connect tubes with size down in the same direction

Plug-in reducer

KGR P.7-134



Used to change size of One-touch fittings.

Tube cap

KGC PP.7-135



Used to plug the unused tube.

Branch "Y"

KGU P.7-133



Used to branch line in the same direction from female thread.

Male connector: KGH

<M5>

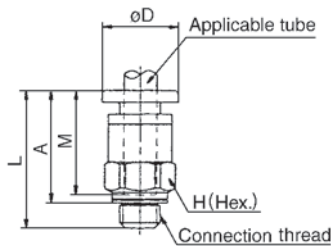

<R(PT)>

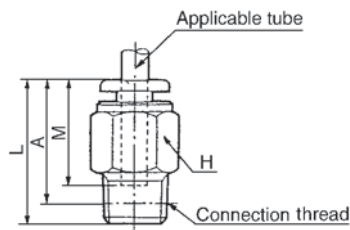

Tube O.D. (mm)	Connection thread R(PT)	Part No.	H (Hex.)	$\phi D^{(1)}$	L	A*	M	Effective area (mm ²) ⁽²⁾		Weight (g)
								Nylon	Urethane	
4	M5	KGH04-M5	8	8	17	13.9	12.7	4	4	2.4
	1/8	KGH04-01	10	—	21.1	18	16	5.6	4	9
	1/4	KGH04-02	14	—	19	13.5	16	5.6	4	16
6	M5	KGH06-M5	10	10	17.8	14.7	13.5	4	4	3.4
	1/8	KGH06-01	12	—	21.6	18.5	17	13.1	10.4	16
	1/4	KGH06-02	14	—	22.5	17	17	13.1	10.4	14
8	3/8	KGH06-03	17	—	20.9	15.5	17	13.1	10.4	27
	1/8	KGH08-01	14	—	27.1	24	18.5	26.1	18.0	21
	1/4	KGH08-02	14	—	26	20.5	18.5	26.1	18.0	19
10	3/8	KGH08-03	17	—	20.9	15.5	18.5	26.1	18.0	26
	1/8	KGH10-01	17	—	29.1	26	21	41.5	29.5	19
	1/4	KGH10-02	17	—	33	27.5	21	41.5	29.5	30
12	3/8	KGH10-03	22	—	27.9	22.5	21	41.5	29.5	30
	1/2	KGH10-04	22	—	26.1	19	22	58.3	46.1	53
	1/4	KGH12-02	19	—	34	28.5	22	58.3	46.1	42
16	3/8	KGH12-03	22	—	28.9	23.5	22	58.3	46.1	34
	1/2	KGH12-04	22	—	29.1	22	24	81	(81)	51
	3/8	KGH16-03	24	—	38.4	32	24	81	(81)	61
16	1/2	KGH16-04	24	—	33.6	26.5	24	113	(96)	47

* Reference dimensions after R(PT) thread installation.

Note1) ϕD : max. diameter

Note2) (): Values for soft nylon.

Hexagon socket head male connector: KGS

<M5>

<R(PT)>

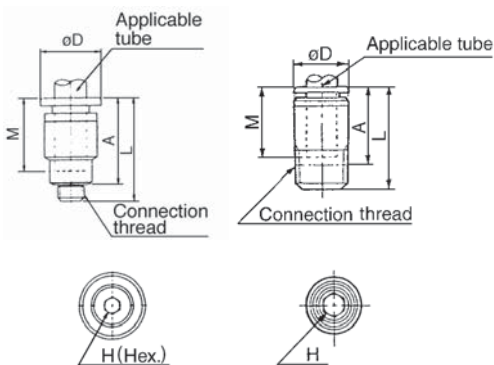

Tube O.D. (mm)	Connection thread R(PT)	Part No.	H (Hex.)	$\phi D^{(1)}$	L	A*	M	Effective area (mm ²)		Weight (g)
								Nylon	Urethane	
4	M5	KGS04-M5	2.5	8	18.7	15.6	12.7	4	4	2.6
	1/8	KGS04-01	3	9.8	22.1	19	16	4.1	3.6	8
6	M5	KGS06-M5	2.5	10	19.5	16.4	13.5	4	4	3.2
	1/8	KGS06-01	4	11.8	23.1	20	17	10.0	9.9	9
	1/4	KGS06-02	4	13.8	23.5	20	17	10.7	10.0	15
8	1/8	KGS08-01	5	14	27.1	24	18.5	17.2	16.2	12
	1/4	KGS08-02	6	14	25	19.5	18.5	23.3	16.2	11
	3/8	KGS08-03	6	17	26.4	21	18.5	23.3	16.2	24
10	1/8	KGS10-01	5	17	29.1	26	21	17.2	10.0	18
	1/4	KGS10-02	8	17	27	21.5	21	39.0	26.6	12
	3/8	KGS10-03	8	17	26.4	21	21	39.0	26.6	19
	1/2	KGS10-04	8	22	27.1	20	21	39.0	26.6	35
12	1/4	KGS12-02	8	19	33	27.5	22	46.0	44.5	23
	3/8	KGS12-03	10	19	27.9	22.5	22	46.0	44.5	18
	1/2	KGS12-04	10	22	27.1	20	22	60.0	44.5	30

* Reference dimensions after R(PT) thread installation.

Note1) ϕD : max. diameter

Stainless One-touch Fittings *Series KG*

Female connector: KGF

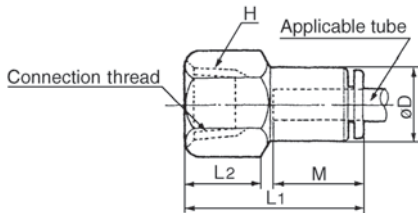

Tube O.D. (mm)	Connection thread R(PT)	Part No.	H (Hex.)	øD ⁽¹⁾	L1	L2	M	Effective area (mm ²)		Weight (g)
								Nylon	Urethane	
4	1/8	KGF04-01	14	10	27	11	16	5.6	4	15
	1/4	KGF04-02	17		31	14				23
6	1/8	KGF06-01	14	12	27.5	11	17	13.1	10.4	15
	1/4	KGF06-02	17		31	13				22
	3/8	KGF06-03	19		33.5	15				25
8	1/8	KGF08-01	14	14	29	11	18.5	26.1	18.0	17
	1/4	KGF08-02	17		32.5	13				24
	3/8	KGF08-03	19		33.5	14				24
10	1/4	KGF10-02	17	17	34.5	14	21	41.5	29.5	27
	3/8	KGF10-03	19		36.5	15				30
12	1/4	KGF12-02	19	19	35	14	22	58.3	46.1	36
	3/8	KGF12-03	19		37					31
	1/2	KGF12-04	24		41					18

□ Reference dimensions after R(PT) thread installation.
Note1) øD: max. diameter

Straight union: KGH

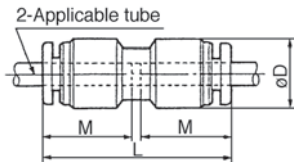

Tube O.D. (mm)	Part No.	øD ⁽¹⁾	L	M	Effective area (mm ²)		Weight (g)
					Nylon	Urethane	
4	KGH04-00	10.4	32.5	16	5.6	4	3
6	KGH06-00	12.8	34.5	17	13.1	10.4	4
8	KGH08-00	15.2	38.5	18.5	26.1	18.0	6
10	KGH10-00	18.5	42.5	21	41.5	29.5	11
12	KGH12-00	20.9	44.5	22	58.3	46.1	14

□ Note1) øD: max. diameter

Different dia. straight: KGH

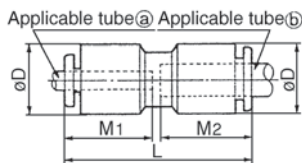

Tube O.D. (mm)		Part No.	øD ⁽¹⁾	L	M1	M2	Effective area (mm ²)		Weight (g)
a	b						Nylon	Urethane	
4	6	KGH04-06	12.8	34.5	16	17	5.6	4	5
6	8	KGH06-08	15.2	38.5	17	18.5	13.1	10.4	6
8	10	KGH08-10	18.5	42	18.5	21	26.1	18.0	11
10	12	KGH10-12	20.9	44.5	21	22	41.5	29.5	14

□ Note1) øD: max. diameter

Male elbow: KGL

<M5>

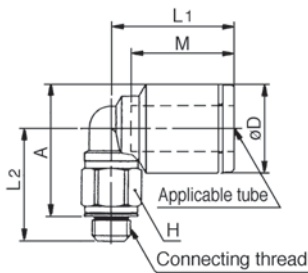

<R(PT)>

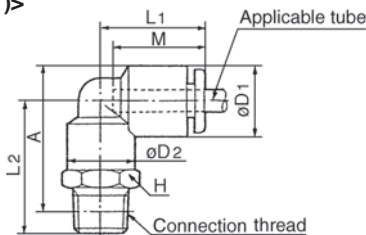

Tube O.D. (mm)	Connection thread R(PT)	Part No.	H (Hex.)	D1 ⁽¹⁾	D2	L1	L2	A*	M	Effective area ⁽²⁾ (mm ²)		Weight (g)
										Nylon	Urethane	
4	M5	KGL04-M5	7	9.3	—	15.6	13.7	15.3	12.7	3.5	3.5	2.7
	1/8	KGL04-01	10	10.4	10	18	21.1	23	16	4.2	4.2	10
	1/4	KGL04-02	14				25.5	25				19
6	M5	KGL06-M5	7	11.6	—	16.1	14.7	17.4	13.5	3.5	3.5	3.1
	1/8	KGL06-01	10	12.8	10	20	22.1	25.5	17	11.4	9.0	12
	1/4	KGL06-02	14				26.5	27.5				10
	3/8	KGL06-03	17	27.9	29	33						
8	1/8	KGL08-01	12	15.2	12	23	23.6	28	18.5	21.6	14.9	13
	1/4	KGL08-02	14				28	30				21
	3/8	KGL08-03	17				29.4	31.5				35
10	1/8	KGL10-01	17	18.5	17	26.5	26.1	32	21	21.6	14.9	25
	1/4	KGL10-02	17				29.5	33				26
	3/8	KGL10-03	17				30.9	34.5		36		
	1/2	KGL10-04	22				35.1	37		63		
12	1/4	KGL12-02	17	20.9	17	28.5	30.5	35.5	22	50.2	39.7	28
	3/8	KGL12-03	17				31.9	37				38
	1/2	KGL12-04	22				36.1	39.5				65
16	3/8	KGL16-03	22	26.5	21	33	36.9	44.5	24	71	(71)	101
	1/2	KGL16-04	22				40.1	46		100	(84)	105

* Reference dimensions after R(PT) thread installation.
Note1) (): Values for soft nylon.
Note2) øD1: max. diameter

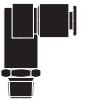

Male branch connector: KGLU

<M5>

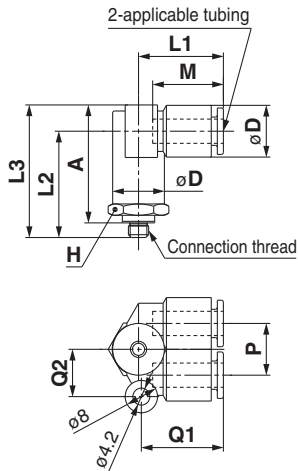

Tube O.D. (mm)	Connection thread R(PT)	Part No.	H (Hex.)	øD ⁽¹⁾	L1	L2	L3	A*	M	P	Q1	Q2	Effective area (mm ²)		Weight (g)	
													Nylon	Urethane		
4	M5	KGLU04-M5	11	10.4	18.5	24	29.5	25.5	16	10.4	18.5	10	4.3	4.1	10	
	1/8	KGLU04-01	14			25.6	31.1	27.5					6.0	4.1	12	
	1/4	KGLU04-02	14			30	35.5	30					21			
6	M5	KGLU06-M5	13	12.8	21	26.5	33	29.5	17	12.8	20.5	12	4.3	4.3	13	
	1/8	KGLU06-01	13			28.6	35.1	32					15			
	1/4	KGLU06-02	14			32.5	39	33.5					22	13.9	11.0	22
	3/8	KGLU06-03	17			33.9	40.4	35					35			
8	1/8	KGLU08-01	17	15.2	24	33.1	40.6	38	18.5	15.2	24.5	14	26.3	18.2	27	
	1/4	KGLU08-02	17			36.5	44	38.5					35			
	3/8	KGLU08-03	17			36.9	44.4	39					35			
10	1/4	KGLU10-02	19	18.5	27	39.5	49	43.5	21	18.5	28	16	40.8	29.0	41	
	3/8	KGLU10-03	19			39.9	49.4	44					42			
	1/2	KGLU10-04	22			43.6	53.1	45.5					64			
12	1/4	KGLU12-02	22	20.9	29	42	52.5	47	22	20.9	30	18	57.2	45.2	57	
	3/8	KGLU12-03	22			42.4	52.9	47.5					58			
	1/2	KGLU12-04	22			45.6	56.1	49					65			

* Reference dimensions after R(PT) thread installation.
Note1) øD: max. diameter



<R(PT)>

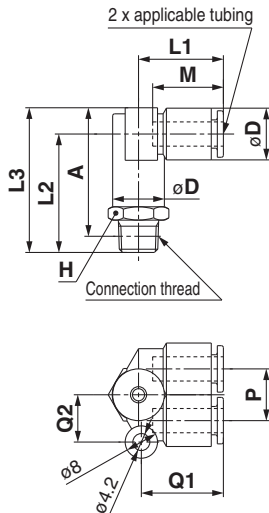

Universal male elbow: KGV

<M5>

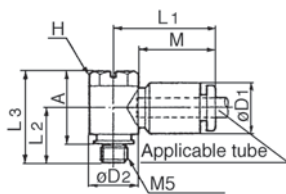

Tube O.D. (mm)	Connection thread R(PT)	Part No.	H (Hex.)	øD ⁽¹⁾	øD2	L1	L2	L3	A*	M	Effective area (mm ²)		Weight (g)
											Nylon	Urethane	
4	M5	KGV04-M5	8	10.4	9.8	20.5	11	18.5	15	16	2.9	2.9	6
	1/8	KGV04-01			13.4	22	13.6	25.6	22.5		14		
6	M5	KGV06-M5	8	12.8	9.8	23.5	12	18.5	15	17	3.8	3.8	7
	1/8	KGV06-01			13.4	24	13.6	25.6	22.5		15		
	1/4	KGV06-02			10	15.3	23.5	18	30.5		25	7.5	7.9
8	1/8	KGV08-01	12	15.2	17.6	28.5	14.6	27.6	24.5	18.5	16	11.2	24
	1/4	KGV08-02			18	31	25.5	30	30				
	3/8	KGV08-03			14	20.6	27.5	19.4	35.4		30	20.5	14.3
10	1/4	KGV10-02	14	18.5	20.6	31	19	35	29.5	21	27	20.3	40
	3/8	KGV10-03					19.4	35.4	30		49		
12	3/8	KGV12-03	17	20.9	25.2	34	20.9	37.4	32	22	39	30.8	63
	1/2	KGV12-04					24.1	40.6	33.5		80		

* Reference dimensions after R(PT) thread installation.
Note1) øD1: max. diameter



<R(PT)>

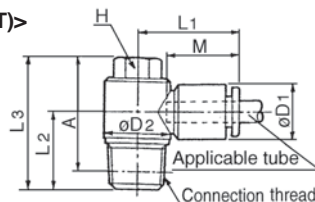

Stainless One-touch Fittings *Series KG*



Union elbow: KGL

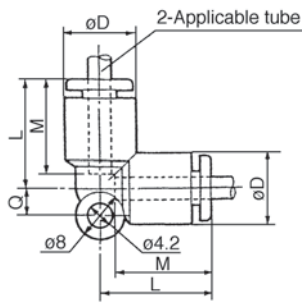

Tube O.D. (mm)	Part No.	øD ⁽¹⁾	L	Q	M	Effective area (mm ²) ⁽²⁾		Weight (g)
						Nylon	Urethane	
4	KGL04-00	10.4	18	4.5	16	4.2	4.2	6
6	KGL06-00	12.8	20	5.3	17	11.4	9.0	6
8	KGL08-00	15.2	23	6	18.5	21.6	14.9	10
10	KGL10-00	18.5	26.5	6.8	21	35.2	25.0	17
12	KGL12-00	20.9	28.5	7.5	22	50.2	39.7	21
16	KGL16-00	26.5	34	10	25	100	(84)	29



Note1) øD: max. diameter
Note2) (): Values for soft nylon.



Branch union elbow: KGLU

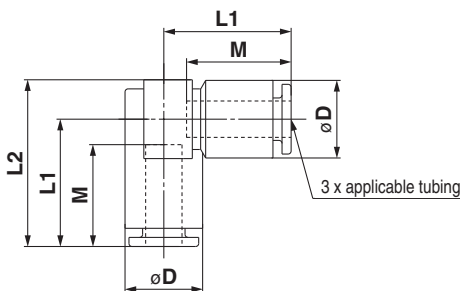

Tube O.D. (mm)	Part No.	øD ⁽¹⁾	L1	L2	Q1	Q2	M	P	Effective area (mm ²)		Weight (g)
									Nylon	Urethane	
4	KGLU04-00	10.4	18.5	24	18.5	10	16	10.4	6.0	4.1	6
6	KGLU06-00	12.8	21	27.5	20.5	12	17	12.8	13.9	11.0	8
8	KGLU08-00	15.2	24	32	24.5	14	18.5	15.2	26.3	18.2	15
10	KGLU10-00	18.5	27	36.5	28	16	21	18.5	40.8	29.0	25
12	KGLU12-00	20.9	29	40	30	18	22	20.9	57.2	45.2	32



Note1) øD: max. diameter

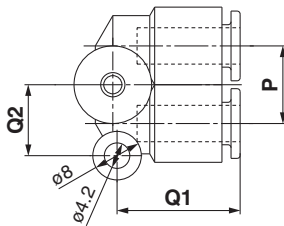

Plug-in elbow: KGL

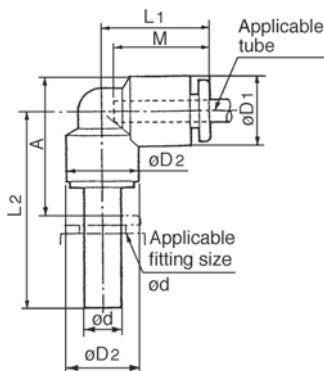

Tube O.D. (mm)	Fitting size ød	Part No.	øD ⁽¹⁾	øD2	L1	L2	A	M	Effective area (mm ²)		Weight (g)
									Nylon	Urethane	
4	4	KGL04-99	10.4	8	18	25	14.5	16	4.2	4.2	8
6	6	KGL06-99	12.8	10	20	27.5	17	17	11.4	9.0	10
8	8	KGL08-99	15.2	12	22.5	31.5	21	18.5	21.6	14.9	14
10	10	KGL10-99	18.5	14	25.5	35.5	23.5	21	35.2	25.0	25
12	12	KGL12-99	20.9	16	27	37.5	26	22	50.2	39.7	28



Note1) øD1: max. diameter





Extended male elbow: KGW

<M5>

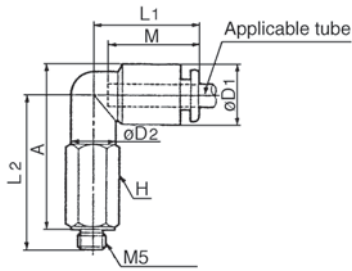

<R(PT)>

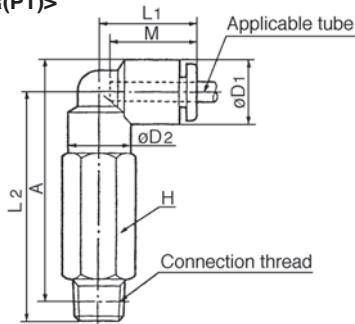

Tube O.D. (mm)	Connection thread R(PT)	Part No.	H (Hex.)	øD ⁽¹⁾	øD ₂	L ₁	L ₂	A*	M	Effective area (mm ²)		Weight (g)		
										Nylon	Urethane			
4	M5	KGW04-M5	8	10.4	8	18	30	32	16	3.0	3.0	11		
	1/8	KGW04-01	10							36.6	38.5	23		
	1/4	KGW04-02	14							43	42.5	38		
6	M5	KGW06-M5	8	12.8	8	20	30.5	33.5	17	3.0	3.0	11		
	1/8	KGW06-01	10							39.1	42.5	26		
	1/4	KGW06-02	14							45.5	46.5	41		
	3/8	KGW06-03	17							46.9	48	67		
8	1/8	KGW08-01	12	15.2	12	23	42.6	47	18.5	20.5	14.2	30		
	1/4	KGW08-02	14									49	51	47
	3/8	KGW08-03	17									50.4	52.5	74
10	1/4	KGW10-02	17	18.5	17	26.5	56	59.5	21	33.5	23.8	66		
	3/8	KGW10-03	17									57.4	61	76
	1/2	KGW10-04	22									64.1	66	145
12	1/4	KGW12-02	17	20.9	17	28.5	57	62	22	47.7	37.7	68		
	3/8	KGW12-03	17									58.4	63.5	78
	1/2	KGW12-04	22									65.1	68.5	147

* Reference dimensions after R(PT) thread installation.
Note1) øD: max. diameter



Branch tee: KGT

<M5>

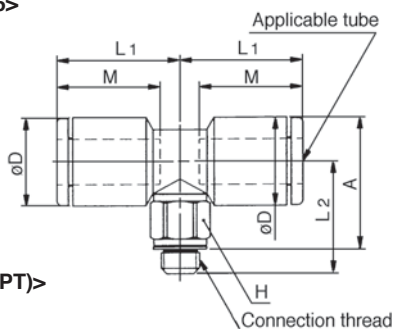

<R(PT)>

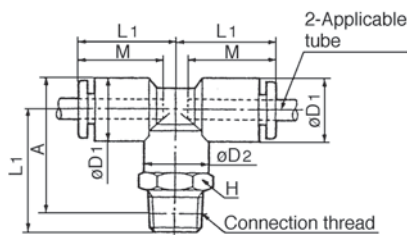

Tube O.D. (mm)	Connection thread R(PT)	Part No.	H (Hex.)	øD ⁽¹⁾	øD ₂	L ₁	L ₂	A*	M	Effective area (mm ²) ⁽²⁾		Weight (g)
										Nylon	Urethane	
4	M5	KGT04-M5	7	9.3	—	15.6	13.7	15.3	12.7	4.3	4.3	3.5
	1/8	KGT04-01	10	10.4	10	18	21.1	23	16	6.0	4.1	13
	1/4	KGT04-02	14				25.5	25				19
6	M5	KGT06-M5	7	11.6	—	16.1	14.7	17.4	13.5	4.3	4.3	4.2
	1/8	KGT06-01	10	12.8	10	20	22.1	25.5	17	13.9	11.0	12
	1/4	KGT06-02	14				26.5	27.5				20
	3/8	KGT06-03	17				27.9	29				34
1/8	KGT08-01	12	23.6				28	14				
8	1/4	KGT08-02	14	15.2	12	23	28	30	18.5	26.3	18.2	22
	3/8	KGT08-03	17				29.4	31.5				36
	1/8	KGT10-01	17				26.1	32				31
10	1/4	KGT10-02	17	18.5	17	26.5	29.5	33	21	40.8	29.0	29
	3/8	KGT10-03	17				30.9	34.5				39
	1/2	KGT10-04	22				35.1	37				66
12	1/4	KGT12-02	17	20.9	17	28.5	30.5	35.5	22	57.2	45.2	31
	3/8	KGT12-03	17				31.9	37				41
	1/2	KGT12-04	22				36.1	39.5				68
16	3/8	KGT16-03	22	26.5	20.9	34	36.9	44.5	25	71	(71)	112
	1/2	KGT16-04	22				39.6	46				116

* Reference dimensions after R(PT) thread installation.
Note1) øD: max. diameter
Note2) (): Values for soft nylon.



Union tee: KGT

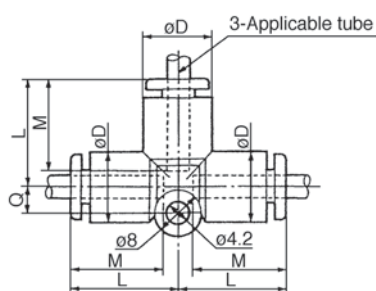

Tube O.D. (mm)	Part No.	øD ⁽¹⁾	L	Q	M	Effective area (mm ²) ⁽²⁾		Weight (g)
						Nylon	Urethane	
4	KGT04-00	10.4	18	4.5	16	6.4	4.4	7
6	KGT06-00	12.8	20	5.3	17	13.4	10.6	10
8	KGT08-00	15.2	23	6	18.5	25.6	17.7	15
10	KGT10-00	18.5	26.5	6.8	21	40	28.4	25
12	KGT12-00	20.9	28.5	7.5	22	57.4	45.4	29
16	KGT16-00	26.5	34	10	25	100	(84)	40

Note1) øD: max. diameter
Note2) (): Values for soft nylon.



Stainless One-touch Fittings Series *KG*

Different diameter tee: KGT

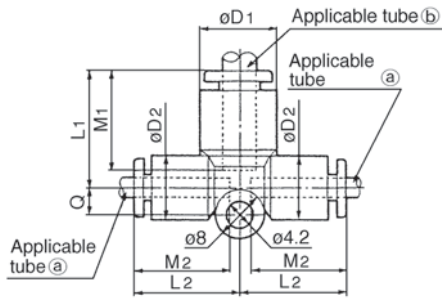

Tube O.D. (mm)		Part No.	$\phi D_1^{(1)}$	ϕD_2	L1	L2	Q	M1	M2	Effective area (mm ²)		Weight (g)
a	b									Nylon	Urethane	
4	6	KGT04-06	12.8	10.4	19.5	18	4.5	17	16	7.1	6.5	5
6	8	KGT06-08	15.2	12.8	22.5	20	5.3	18.5	17	16.4	16.4	8
8	10	KGT08-10	18.5	15.2	26.5	23	6	21	18.5	36	27.2	14
10	12	KGT10-12	20.9	18.5	28.5	26.5	6.8	22	21	56	44.5	21

Note1) ϕD_1 : max. diameter

Male run tee: KGY

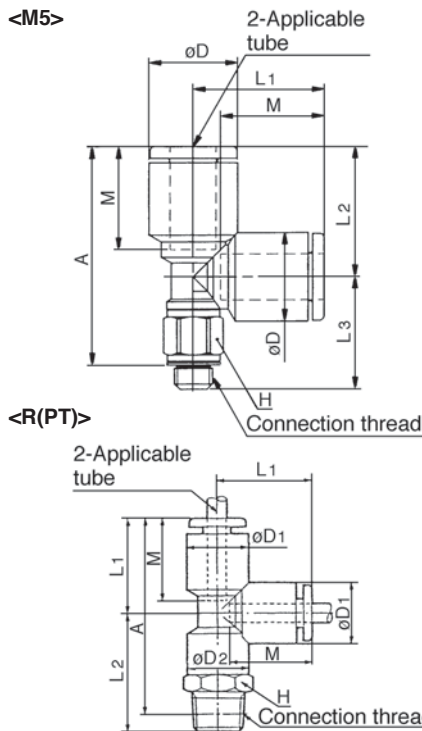

Tube O.D. (mm)	Connection thread R(PT)	Part No.	H (Hex.)	$\phi D_1^{(1)}$	ϕD_2	L1	L2	L3	A*	M	Effective area (mm ²) ⁽²⁾		Weight (g)	
											Nylon	Urethane		
4	M5	KGY04-M5	7	9.3	—	15.6	13.7	14.8	25.4	12.7	4.6	4.6	3.5	
	1/8	KGY04-01	10	10.4	10	18	21.1	—	36	16	6.4	4.4	13	
	1/4	KGY04-02	14				25.5						19	
6	M5	KGY06-M5	7	11.6	—	17.1	14.7	17.1	28.7	13.5	4.6	4.6	4.3	
	1/8	KGY06-01	10	12.8	10	20	22.1	—	39	17	13.4	10.6	12	
	1/4	KGY06-02	14				26.5						20	
	3/8	KGY06-03	17				27.9						20	42.5
1/2	KGY06-04	22	35.1				20						54.5	66
8	1/8	KGY08-01	12	15.2	12	23	23.6	—	43.5	17	13.4	10.6	14	
	1/4	KGY08-02	14				28						14	
	3/8	KGY08-03	17				29.4						14	47
10	1/8	KGY10-01	17	18.5	17	26.5	26.1	—	49.5	21	40.0	28.4	31	
	1/4	KGY10-02	17				29.5						21	29
	3/8	KGY10-03	17				30.9						21	39
	1/2	KGY10-04	22				35.1						21	66
12	1/4	KGY12-02	17	20.9	17	28.5	30.5	—	53.5	22	57.4	45.4	31	
	3/8	KGY12-03	17				31.9						22	41
	1/2	KGY12-04	22				36.1						22	68
16	3/8	KGY16-03	22	26.5	20.9	34	36.9	—	65.5	25	81	(81)	112	
	1/2	KGY16-04	22	40.1	34	40.1	67						113	(113)

* Reference dimensions after R(PT) thread installation.

Note1) ϕD_1 : max. diameter
Note2) (): Values for soft nylon.

Male delta: KGD

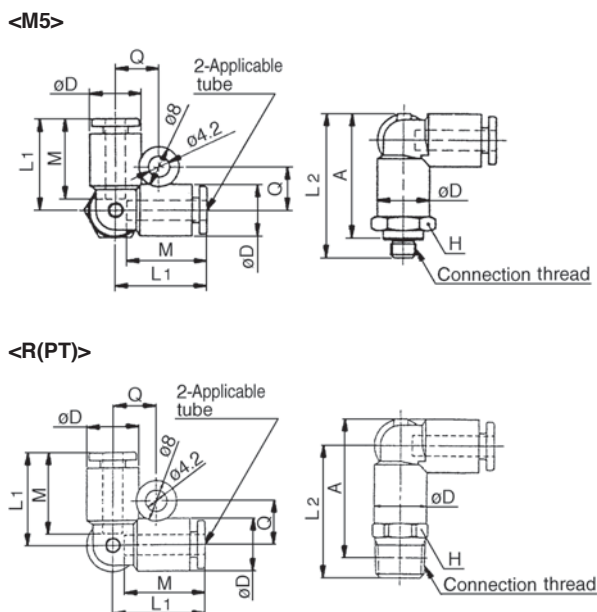

Tube O.D. (mm)	Connection thread R(PT)	Part No.	H (Hex.)	$\phi D^{(1)}$	L1	L2	A*	M	Q	Effective area (mm ²)		Weight (g)
										Nylon	Urethane	
4	M5	KGD04-M5	11	10.4	18.5	24	25.5	16	8.7	4.3	4.3	10
	1/8	KGD04-01	14			25.6	27.5					12
	1/4	KGD04-02	14			30	30					21
6	M5	KGD06-M5	13	12.8	20.5	26	28.5	17	9.9	4.3	4.3	12
	1/8	KGD06-01	14			28.1	31.5					14
	1/4	KGD06-02	14			32	33					21
	3/8	KGD06-03	17			33.4	34.5					34
8	1/8	KGD08-01	17	15.2	23.5	32.6	37	18.5	11.1	26.3	18.2	26
	1/4	KGD08-02	17			36	38					35
	3/8	KGD08-03	17			36.4	38.5					39
10	1/4	KGD10-02	19	18.5	26.5	39	43	21	12.8	40.8	29.0	39
	3/8	KGD10-03	19			39.4	43.5					40
	1/2	KGD10-04	22			43.1	45					62
12	1/4	KGD12-02	22	20.9	28.5	41.5	46.5	22	13.9	57.2	45.2	55
	3/8	KGD12-03	22			41.9	47					56
	1/2	KGD12-04	22			45.1	48.5					63

* Reference dimensions after R(PT) thread installation.

Note1) ϕD : max. diameter



Delta: KGD

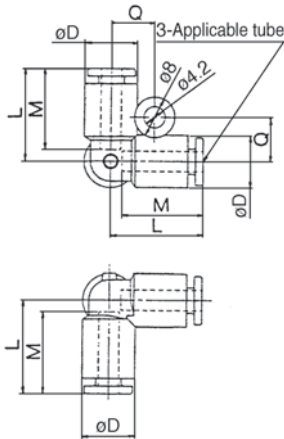

Tube O.D. (mm)	Part No.	øD ⁽¹⁾	L	Q	M	Effective area (mm ²)		Weight (g)
						Nylon	Urethane	
4	KGD04-00	10.4	18.5	8.7	16	6.0	4.1	5
6	KGD06-00	12.8	20.5	9.9	17	13.9	11.0	7
8	KGD08-00	15.2	23.5	11.1	18.5	26.3	18.2	11
10	KGD10-00	18.5	26.5	12.8	21	40.8	29.0	19
12	KGD12-00	20.9	28.5	13.9	22	57.2	45.2	24

Note1) øD: max. diameter

Branch "Y": KGU

<M5>

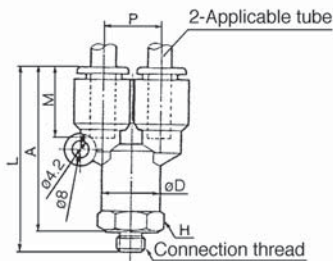

<R(PT)>

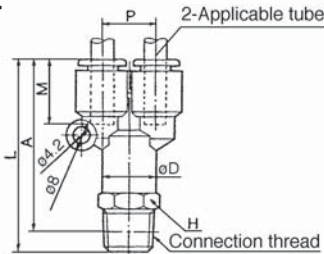

Tube O.D. (mm)	Connection thread R(PT)	Part No.	H (Hex.)	øD ⁽¹⁾	L	P	A*	M	Effective area (mm ²)		Weight (g)
									Nylon	Urethane	
4	M5	KGU04-M5	11	10.4	39.5	10.4	36	16	2.2	2.2	4
	1/8	KGU04-01	14		41.1		38		4.2	4.2	11
	1/4	KGU04-02	14		45.5		40		20		
6	M5	KGU06-M5	13	12.8	42.5	12.8	39	17	2.2	2.2	12
	1/8	KGU06-01	14		44.6		41.5		11		
	1/4	KGU06-02	14		48.5		43		21		
	3/8	KGU06-03	17		49.9		44.5		34		
8	1/8	KGU08-01	17	15.2	51.6	15.2	48.5	18.5	25.6	17.7	15
	1/4	KGU08-02			55		49.5				23
	3/8	KGU08-03			55.4		50				35
10	1/4	KGU10-02	19	18.5	60.5	18.5	55	21	40	28.4	30
	3/8	KGU10-03			64.1		57				40
	1/2	KGU10-04			22		64.1				57
12	1/4	KGU12-02	22	20.9	64	20.9	58.5	22	57.4	45.4	32
	3/8	KGU12-03			64.4		59				40
	1/2	KGU12-04			22		67.6				60.5

* Reference dimensions after R(PT) thread installation.
Note1) øD: max. diameter

Double branch: KGUD

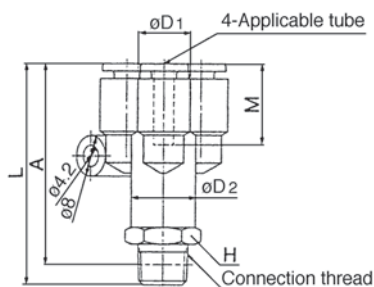

Tube O.D. (mm)	Connection thread R(PT)	Part No.	H (Hex.)	øD ⁽¹⁾	øD ₂	L	I	A*	Q	M	P	Effective area (mm ²)		Weight (g)
												Nylon	Urethane	
4	1/8	KGUD04-01	13	10.4	12.8	42.6	21	39.5	9.7	16	10.4	4.2	4.2	17
	1/4	KGUD04-02	14			46.5		41				25		
6	1/8	KGUD06-01	17	12.8	15.2	49.6	26	46.5	11.7	17	12.8	13.4	10.6	29
	1/4	KGUD06-02				53		47.5				29		

* Reference dimensions after R(PT) thread installation.
Note1) øD: max. diameter

Stainless One-touch Fittings *Series KG*



Union "Y": KGU

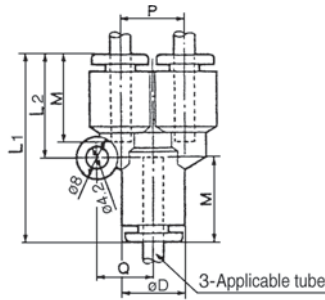

Tube O.D. (mm)	Part No.	øD ⁽¹⁾	L1	L2	P	Q	M	Effective area (mm ²)		Weight (g)
								Nylon	Urethane	
4	KGU04-00	10.4	34	18	10.4	9.7	16	4.2	4.2	7
6	KGU06-00	12.8	37	20	12.8	11.7	17	13.4	10.6	9
8	KGU08-00	15.2	42.5	24.5	15.2	13.7	18.5	25.6	17.7	11
10	KGU10-00	18.5	48	27.5	18.5	16.1	21	40	28.4	16
12	KGU12-00	20.9	51	30	20.9	18.1	22	57.4	45.4	23

Note1) øD: max. diameter

Different diameter union "Y": KGU

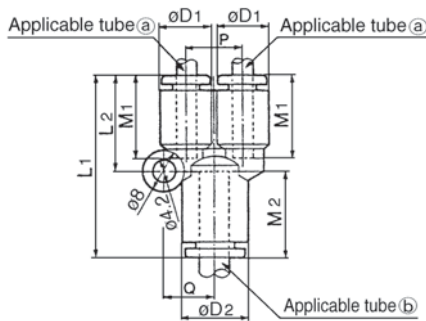

Tube O.D. (mm)		Part No.	øD ⁽¹⁾	øD ⁽¹⁾	L1	L2	P	Q	M1	M2	Effective area (mm ²)		Weight (g)
a	b										Nylon	Urethane	
4	6	KGU04-06	10.4	12.8	35	18	10.4	9.7	16	17	4.2	4.2	6
6	8	KGU06-08	12.8	15.2	39.5	20	12.8	11.7	17	18.5	13.4	10.6	11
8	10	KGU08-10	15.2	18.5	45	24.5	15.2	13.7	18.5	21	25.6	17.7	18
10	12	KGU10-12	18.5	20.9	49	27.5	18.5	16.1	21	22	40	28.4	27

Note1) øD1, øD2: max. diameter

Different diameter double union "Y": KGUD

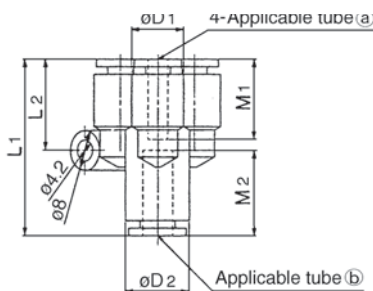

Tube O.D. (mm)		Part No.	øD ⁽¹⁾	øD ⁽¹⁾	L1	L2	P	I	Q	M1	M2	Effective area (mm ²)		Weight (g)
a	b											Nylon	Urethane	
4	6	KGUD04-06	10.4	12.8	35.5	18.2	10.4	21	9.7	16	17	4.2	4.2	10
6	8	KGUD06-08	12.8	15.2	40.5	20.3	12.8	26	11.7	17	18.5	13.4	10.6	17

Note1) øD1, øD2: max. diameter

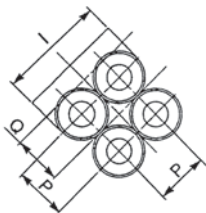

Plug-in reducer: KGR

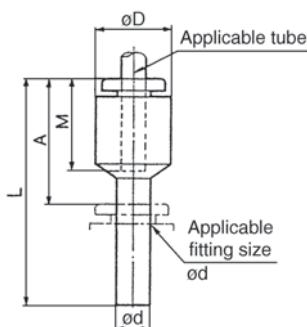

Tube O.D. (mm)	Fitting size ød	Part No.	øD ⁽¹⁾	L	A□	M	Effective ⁽²⁾ area (mm ²)		Weight (g)
							Nylon	Urethane	
4	6	KGR04-06	10.4	34.5	17.5	16	5.6	4	1.8
	8	KGR04-08		36.5	18				2.0
	10	KGR04-10		39.5	18.5				3.3
6	4	KGR06-04	12.8	37	21	17	13.1	10.4	3
	8	KGR06-08		37	18.5				2.5
	10	KGR06-10		39.5					3
	12	KGR06-12		42	20				4.7
8	10	KGR08-10	15.2	41	20	18.5	26.1	18.0	4.0
	12	KGR08-12		42					4.6
10	12	KGR10-12	17	44.5	23	21	41.5	32.8	33
	16	KGR10-16	20.9	50.5	25.5				(29.5)
12	16	KGR12-16	20.9	50.5	25.5	22	58.3	(46.1)	37

Note1) øD: max. diameter
Note2) (): Values for soft nylon.



Bulkhead union: KGE

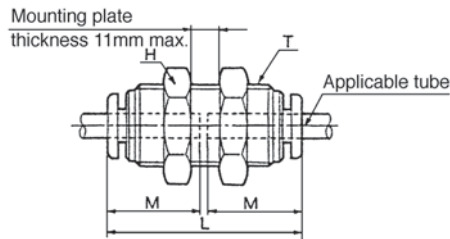

Tube O.D. (mm)	Part No.	T(M)	H (Hex.)	L	Mounting hole	M	Effective ⁽¹⁾ area (mm ²)		Weight (g)
							Nylon	Urethane	
4	KGE04-00	M12 X 1	14	32.5	13	16	5.6	4	26
6	KGE06-00	M14 X 1	17	34.5	15	17	13.1	10.4	33
8	KGE08-00	M16 X 1	19	38	17	18.5	26.1	18.0	52
10	KGE10-00	M20 X 1	24	42.5	21	21	41.5	29.5	70
12	KGE12-00	M22 X 1	27	44	23	22	58.3	46.1	90
16	KGE16-00	M28 X 1.5	32	51	29	25	113	(96)	115



Note1) (): Values for soft nylon.

Bulkhead connector: KGE

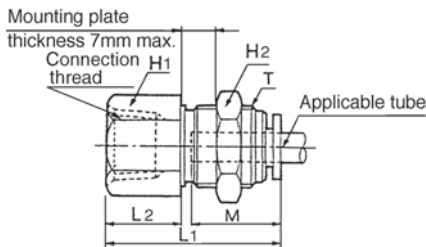

Tube O.D. (mm)	Connection thread R(PT)	Part No.	T(M)	H1 (Hex.)	H2 (Hex.)	L1	L2	Mounting hole	M	Effective ⁽¹⁾ area (mm ²)		Weight (g)			
										Nylon	Urethane				
4	1/8	KGE04-01	M12 X 1	14	14	27.5	11	13	16	5.6	4	16			
	1/4	KGE04-02		17		31	15					35			
6	1/8	KGE06-01	M14 X 1	17	17	31.5	11	15	15	17	13.1	10.4	30		
	1/4	KGE06-02											33.5	17	29
	3/8	KGE06-03											33.5	17	29
8	1/8	KGE08-01	M16 X 1	17	19	27.5	7.5	17	18.5	26.1	18.0	28			
	1/4	KGE08-02										33	13	27	
	3/8	KGE08-03										35	15	48	
10	1/4	KGE10-02	M20 X 1	22	24	34.5	12.5	21	21	41.5	29.5	53			
	3/8	KGE10-03				36.5	14					67			
12	3/8	KGE12-03	M22 X 1	24	27	37	14	23	22	58.3	46.1	92			
	1/2	KGE12-04				41	18					59			
16	3/8	KGE16-03	M28 X 1.5	30	32	40	14	29	25	96	(96)	127			
	1/2	KGE16-04				44	18					113	132		



Note1) (): Values for soft nylon.

Tube cap: KGC

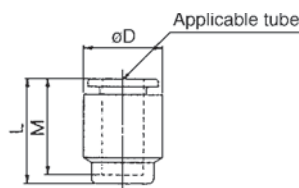

Tube O.D. (mm)	Part No.	øD ⁽¹⁾	L	M	Weight (g)
4	KGC04-00	10.4	17	16	3
6	KGC06-00	12.8	18.5	17	3
8	KGC08-00	15.2	20.5	18.5	4
10	KGC10-00	18.5	23	21	6
12	KGC12-00	20.9	24	22	8
16	KGC16-00	26.5	28	25	13



Note1) øD: max. diameter