

# OSHA Standard Compliant Pressure Relief 3-Port Valve with Locking Holes

New  
RoHS

Improved flow rate characteristics

Max. **75**<sup>\*1</sup> % increase

\*1 VHS40-04-D

Energy saving

Zero blow-by of the air during switching of the handle

Safety measure

OSHA (Occupational Safety and Health Administration) standard compliant



Modular design with uniform body style to F.R.L. units.

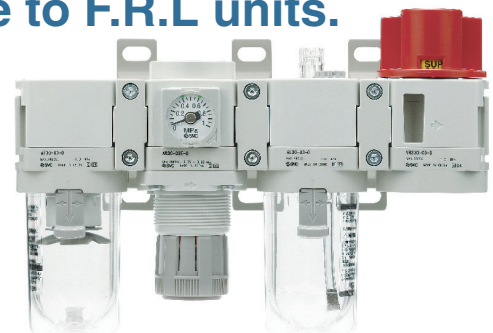
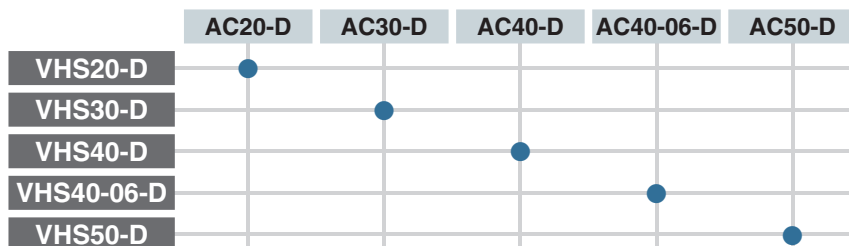

## Variations

Single action		VHS20-D	VHS30-D	VHS40-D	VHS40-06-D	VHS50-D
Double action		VHS20W-D	VHS30W-D	VHS40W-D	VHS40W-06-D	VHS50W-D
Port size (Rc, NPT, G)	1/8	●				
	1/4	●	●	●		
	3/8		●	●		
	1/2			●		
	3/4				●	●
	1					●

Single Action **VHS20/30/40/50-D Series**

Double Action **VHS20W/30W/40W/50W-D Series**



CAT.EUS13-12A-UK

## Improved flow rate characteristics

Max. **75%** increase

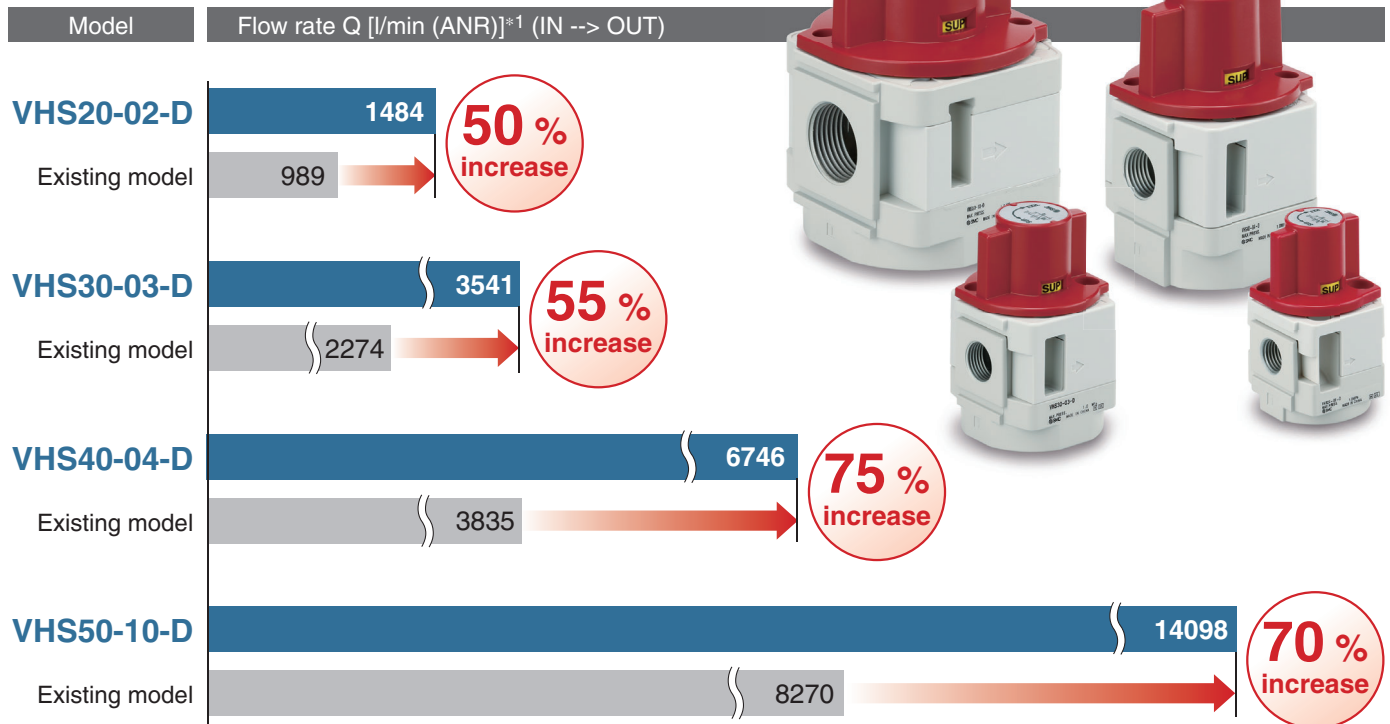

\*1 These values have been calculated according to ISO 6358 and indicate the flow rate under standard conditions with an inlet pressure of 0.6 MPa (relative pressure) and a pressure drop of 0.1 MPa.

## Safety measure

Can prevent accidents caused by inadvertent air supply problems

### With the indicator window



The supply/exhaust status of the air flow can be verified at a glance in the indicator window.

**SUP** : Supply **EXH** : Exhaust

### Double action

Push the handle and then turn, **2-step** action prevents malfunction.

#### Step 1

Push down the handle.



#### Step 2

Turn the handle.



## OSHA (Occupational Safety and Health Administration) standard compliant

For safety control, OSHA rule requires energy sources for certain equipment be turned off or disconnected and that the device either be locked or labelled with a warning tag.

### With locking holes

When in the exhaust position, the valve may be padlock secured. Prevents accidental start-ups while personnel are cleaning or servicing equipment.

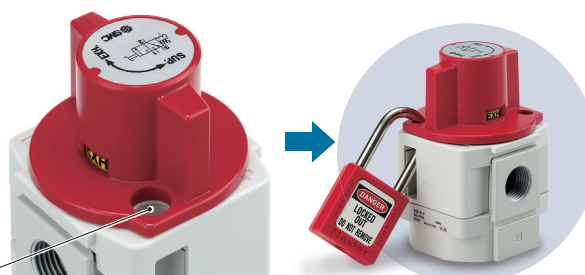

\* Recommended lock shackle diameter size: Ø 5 or more

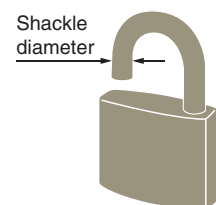

# Lower pressure drop contributing to energy saving

Pressure drop: reduced by up to **73 %**

(\* for flow rate up to 1500 l/min.)

<Typical example> VHS30-03-D Inlet pressure: 0.5 MPa

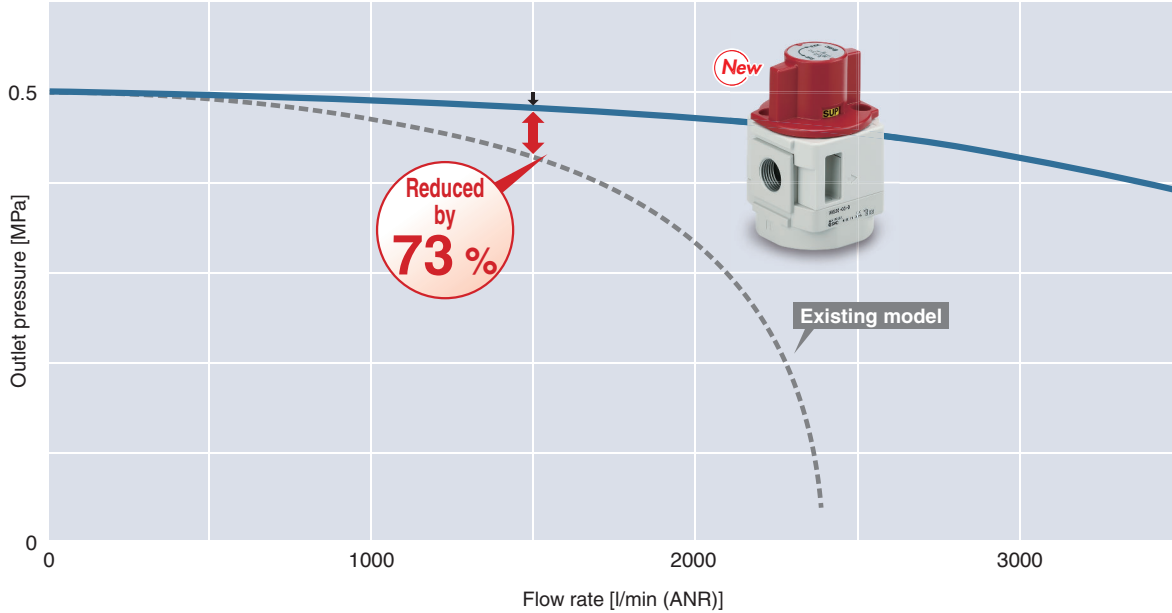

## Options

### With bracket

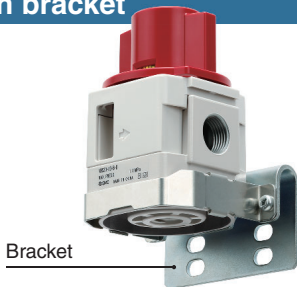

### With built-in silencer (for EXH port)

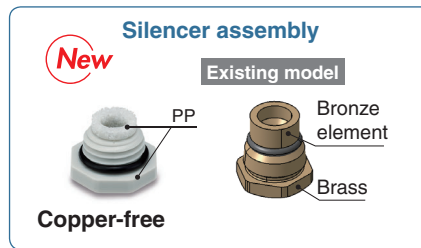

With a built-in silencer option

When a silencer is mounted afterwards.

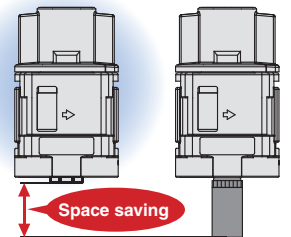

## Semi-standard/Made to Order

Semi-standard... **Handle colour: Black** **Handle material: Metal** **Flow direction: Right to left** **Pressure unit: psi**

Option ..... **With bracket** **With built-in silencer (for EXH port)**

Made to Order... **Body colour: Red + Flame resistant**

**Made to Order**  
Red body +  
Flame resistant (-X1)

**Flame resistant PBT**  
· Handle  
· Body cover  
· Valve guide



**Semi-standard**  
Black handle (-K)



**Semi-standard**  
Metal handle (-M)



# OSHA Standard Compliant Pressure Relief 3-Port Valve with Locking Holes

Single Action

## VHS20/30/40/50-D Series

RoHS

Double Action

## VHS20W/30W/40W/50W-D Series

### Symbol

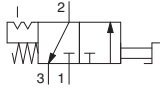

### How to Order

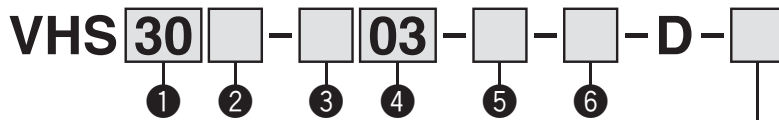

Made to Order

(For details, refer to page 8.)

· Option/Semi-standard: Select one each for a to f.  
 · Option/Semi-standard symbol:  
 When more than one specification is required, indicate in alphanumeric order.  
 Example) VHS30-N03-BS-RZ-D

	Symbol	Description	① Body size				
			20	30	40	50	
② Handle operation	—	Single action	●	●	●	●	
	W	Double action	●	●	●	●	
③ Pipe thread type	—	Rc*1	●	●	●	●	
	N	NPT	●	●	●	●	
	F	G	●	●	●	●	
④ Port size	01	1/8	●	—	—	—	
	02	1/4	●	●	●	—	
	03	3/8	—	●	●	—	
	04	1/2	—	—	●	—	
	06	3/4	—	—	●	●	
	10	1	—	—	—	●	
⑤ Option	a Mounting	—	Without mounting option	●	●	●	●
		B	With bracket	●	●	●	●
	b Silencer	—	Without silencer	●	●	●	●
		S	With built-in silencer (for EXH port)	●	●	●	●
⑥ Semi-standard	c Handle colour	—	Red	●	●	●	●
		K	Black	●	●	●	●
	d Handle material	—	Resin	●	●	●	●
		M	Metal	●	●	●	●
	e Flow direction	—	Flow direction: Left to right	●	●	●	●
		R	Flow direction: Right to left	●	●	●	●
f Pressure unit	—	Product label in SI units: MPa	●	●	●	●	
	Z*2	Product label in imperial units: psi	○*3	○*3	○*3	○*3	

\*1 The pipe thread type for the EXH port is G.

\*2 For the pipe thread type: NPT only. This product is for overseas use only according to the New Measurement Act. (The SI unit type is provided for use in Japan.)

\*3 ○: For the pipe thread type: NPT only

## Simple Specials System A system designed to respond quickly and easily to your special ordering needs

For modular connection units (shipped assembled), the simple specials system can be used.

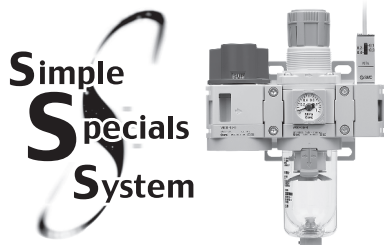

### Short lead times

This system enables us to respond to your special needs (additional machining, accessory assembly, or the designing of a modular unit) and deliver your personalised products as quickly as standard products.

### Repeat orders

Once we receive a simple special part number from one of your previous orders, we will process the order, manufacture the product, and deliver it to you as quickly as possible.

Please contact your local sales representative for more details.

# OSHA Standard Compliant Pressure Relief 3-Port Valve with Locking Holes *VHS20/30/40/50-D Series*



## Specifications

### Standard Specifications

Model	VHS20-D	VHS30-D	VHS40-D	VHS40-06-D	VHS50-D
Applicable AC size	AC20-D	AC30-D	AC40-D	AC40-06-D	AC50-D AC60-D*1
Fluid	Air				
Ambient and fluid temperatures	-5 to 60 °C (No freezing)				
Proof pressure	1.5 MPa				
Max. operating pressure	1.0 MPa				
Handle switching angle	90°				
Paint colour	Handle: Red Body: White Body cover: White				
Weight	0.10 kg	0.18 kg	0.40 kg	0.43 kg	0.82 kg

\*1 The VHS50 can be connected to the AC60.

OSHA standard (Occupational Safety and Health Administration, U.S. Department of Labor)

For safety control, OSHA rule requires energy sources for certain equipment be turned off or disconnected and that the device either be locked or labelled with a warning tag.

### Flow Rate Characteristics

Model	Port size		Flow rate characteristics							
	IN, OUT	EXH	IN → OUT				OUT → EXH			
			C (dm <sup>3</sup> /s·bar)	b	Cv	Q [l/min (ANR)]*1	C (dm <sup>3</sup> /s·bar)	b	Cv	Q [l/min (ANR)]*1
VHS20-D	1/8	1/8	4.0	0.41	1.1	1096	3.7	0.42	1.1	1021
	1/4		5.8	0.31	1.4	1484	3.8	0.42	1.1	1049
VHS30-D	1/4	1/4	8.8	0.44	2.4	2466	8.0	0.46	2.3	2277
	3/8		14.1	0.28	3.5	3541	7.8	0.46	2.2	2220
VHS40-D	1/4	3/8	9.5	0.49	2.8	2769	13.3	0.47	3.6	3815
	3/8		17.2	0.47	4.8	4934	13.6	0.47	3.7	3901
	1/2		26.7	0.29	6.3	6746	13.4	0.43	3.7	3727
VHS40-06-D	3/4	1/2	34.0	0.22	7.6	8237	16.1	0.41	4.4	4412
VHS50-D	3/4	1/2	45.0	0.26	10.6	11163	23.0	0.49	6.4	6705
	1		53.3	0.36	13.5	14098	22.8	0.49	6.3	6647

\*1 These values have been calculated according to ISO 6358 and indicate the flow rate under standard conditions with an inlet pressure of 0.6 MPa (relative pressure) and a pressure drop of 0.1 MPa.

### Option/Part Nos.

Optional specifications	Model				
	VHS20-D	VHS30-D	VHS40-D	VHS40-06-D	VHS50-D
Bracket assembly*1	VHS24P-180AS	VHS34P-180AS	VHS44P-180AS	VHS44P-180AS	VHS54P-180AS
Silencer assembly*2	VHS24P-190AS	VHS34P-190AS	VHS44P-190AS	VHS54P-190AS	VHS54P-190AS

\*1 The assembly consists of a bracket A/B and 2 mounting screws.

\*2 The assembly consists of the element assembly and an O-ring.

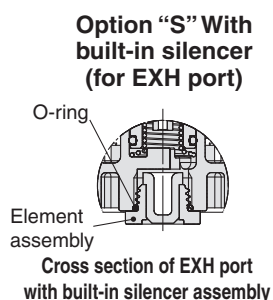
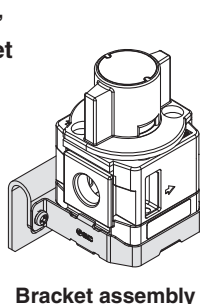
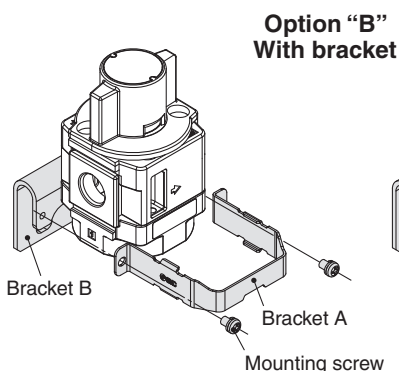



# VHS20/30/40/50-D Series

## Dimensions

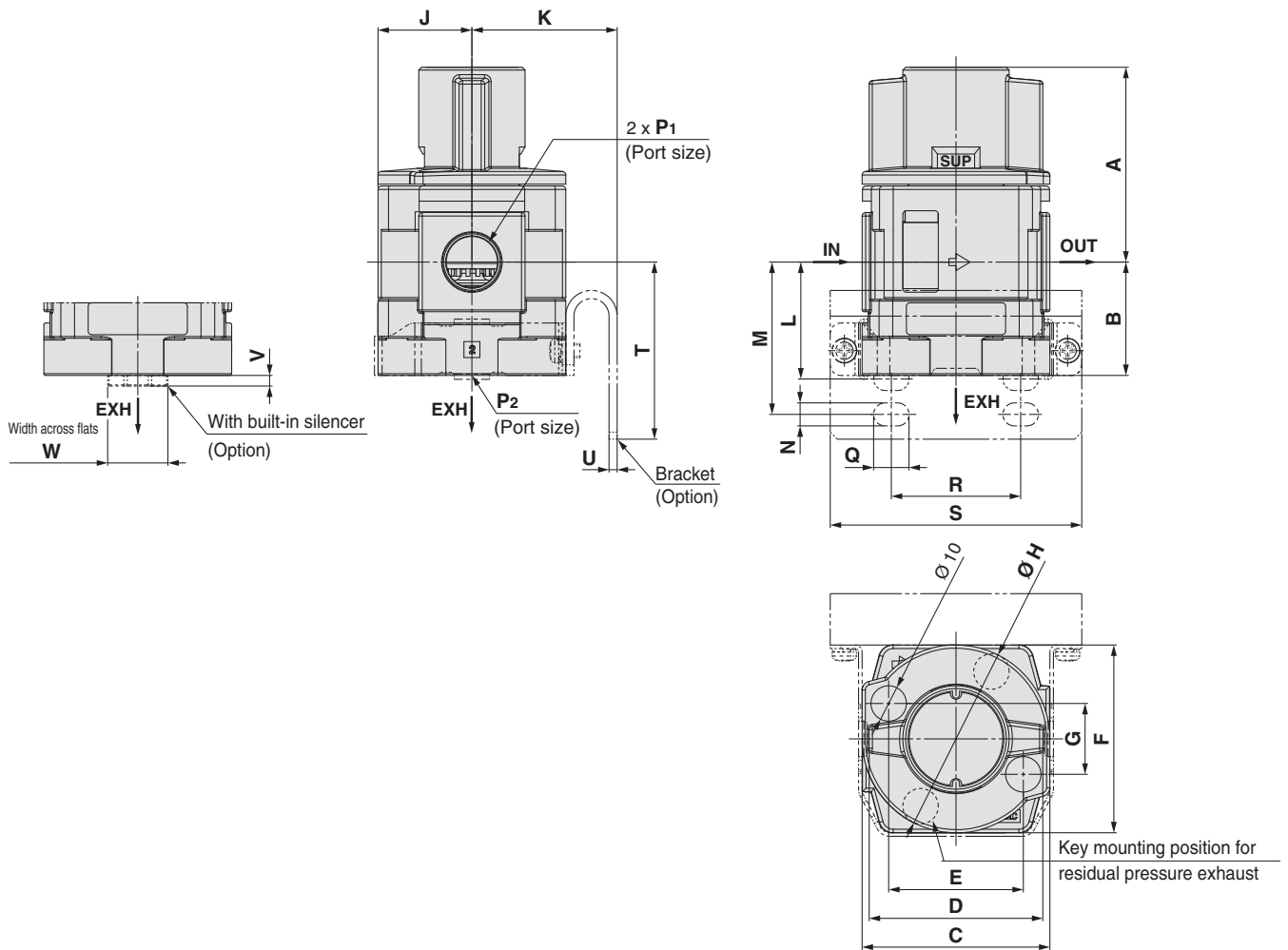

## Dimensions

[mm]

Model	Standard specifications											
	P <sub>1</sub>	P <sub>2</sub>	A		B	C	D	E	F	G	H	J
			Single	Double								
VHS20-D	1/8, 1/4	1/8	48.5	51.7	23	40	37	28	42	17.5	40	21
VHS30-D	1/4, 3/8	1/4	55	58.2	32	53	49	38	53	20	53	26.5
VHS40-D	1/4, 3/8, 1/2	3/8	69.7	73.9	41.3	70	63	52	71	29	70	35.5
VHS40-06-D	3/4	1/2	71.7	75.9	43.3	75	63	52	71	29	70	35.5
VHS50-D	3/4, 1	1/2	86.5	90.7	44.5	90	80	72	90	33	90	45

Model	Options specifications										
	With bracket									With silencer	
	K	L	M	N	Q	R	S	T	U	V	W
VHS20-D	30	25.3	34	5.4	8.4	27	60	40	2.3	3	13
VHS30-D	41	33	43	6.5	10	36.5	71	50	2.3	3	17
VHS40-D	50	44	57	8.5	19	43.5	88	66	2.3	3	21
VHS40-06-D	50	46	59	8.5	19	43.5	88	68	2.3	4	27
VHS50-D	70	60	—	11	27.5	49.5	113	71	3.2	4	27

# VHS20/30/40/50-D Series Modular Connection Example

Please note that products do not come assembled. They should be ordered separately and assembled by the customer.

For modular connection units (shipped assembled), the simple specials system can be used. For details, refer to page 3.

## Combination example ①

Pressure relief 3-port valve VHS30-03-D — 1 pc.  
 Spacer with bracket Y300T-D — 2 pcs.  
 Filter regulator with backflow function AW30K-03E-D — 1 pc.  
 Pressure switch with L-shaped piping adapter IS10L-30-03-D — 1 pc.

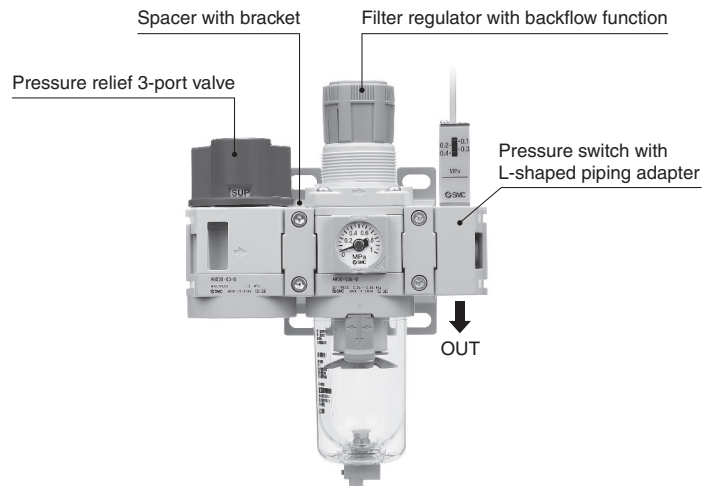

## Combination example ②

L-shaped piping adapter E300L-03-D — 1 pc.  
 Spacer with bracket Y300T-D — 4 pcs.  
 Air filter AF30-03-D — 1 pc.  
 Regulator AR30-03E1-D — 1 pc.  
 Cross spacer Y34-03-D — 1 pc.  
 Pressure relief 3-port valve VHS30-03-D — 1 pc.

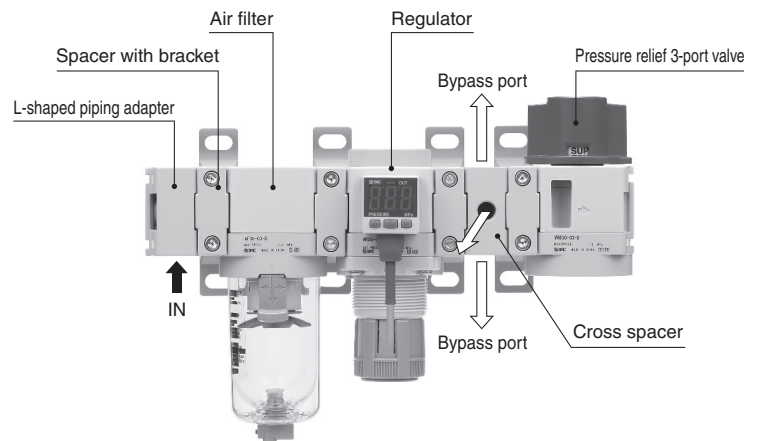

## Combination example ③

Pressure relief 3-port valve VHS30-03-D — 1 pc.  
 Spacer with bracket Y300T-D — 4 pcs.  
 Air filter AF30-03-D — 1 pc.  
 Common supply regulator with backflow function AR30MK-0302E-D — 2 pcs.  
 Regulator with backflow function AR30K-03E-D — 1 pc.

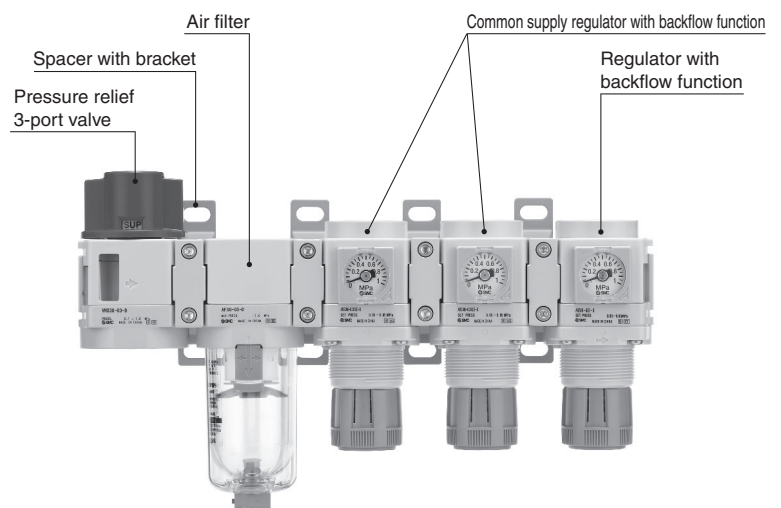

# VHS20/30/40/50-D Series

## Accessories Sold Separately (for Individual Parts)

### Spacer/Spacer with Bracket

Y **300** **□** - D

①      ②

	Symbol	Description	①				
			Body size [Applicable VHS size]				
			200 [VHS20]	300 [VHS30]	400 [VHS40]	500 [VHS40-06]	600 [VHS50]
②	—	Spacer	●	●	●	●	●
	T	Spacer with bracket	●	●	●	●	●

Spacer  
(Y□-D)



Spacer with bracket  
(Y□T-D)



### Standard Specifications

Fluid	Air
Ambient and fluid temperatures	-5 to 60 °C (No freezing)
Proof pressure	1.5 MPa
Max. operating pressure	1.0 MPa

### Replacement Parts

Description	Material	Part number				
		Y200-D Y200T-D	Y300-D Y300T-D	Y400-D Y400T-D	Y500-D Y500T-D	Y600-D Y600T-D
Seal	HNBR	Y220P-050S	Y320P-050S	Y420P-050S	Y520P-050S	Y620P-050S

### Dimensions

#### Spacer

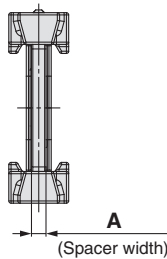
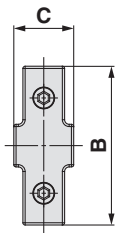
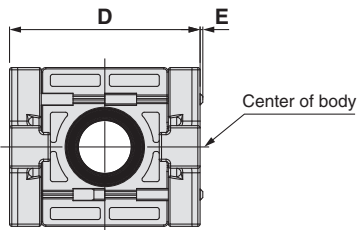

#### Spacer with bracket

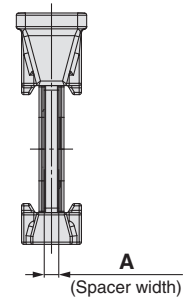
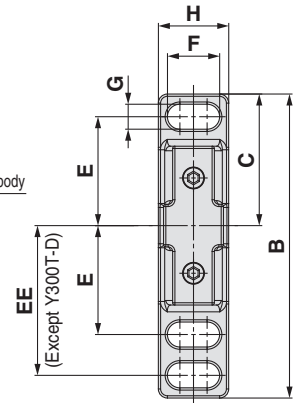
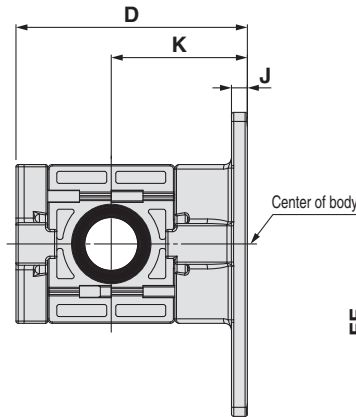

Part no.	A	B	C	D	E	Applicable model
Y200-D	3.2	35	13.2	42	0.6	VHS20-D
Y300-D	4.2	43	16.2	53	—	VHS30-D
Y400-D	5.2	51	19.2	71	—	VHS40-D
Y500-D	5.2	54	21.2	71	—	VHS40-06-D
Y600-D	6.2	64	27.2	90	—	VHS50-D

Part no.	A	B	C	D	E	EE	F	G	H	J	K	Applicable model
Y200T-D	3.2	67	29	51	24	33	11.5	5.5	15.5	3.5	30	VHS20-D
Y300T-D	4.2	85	42.5	67.5	35	—	14	7	20	6	41	VHS30-D
Y400T-D	5.2	115	50	85.5	40	55	18	9	26	7	50	VHS40-D
Y500T-D	5.2	115	50	85.5	40	55	18	9	26	7	50	VHS40-06-D
Y600T-D	6.2	140	60	115	50	70	20	11	31.2	8	70	VHS50-D



# VHS20/30/40/50-D Series

## Made to Order

Please contact SMC for detailed dimensions, specifications, and delivery times.



### ① Body Colour: Red + Flame Resistant

The body colour is red. Flame resistant resin is used for the exterior parts.

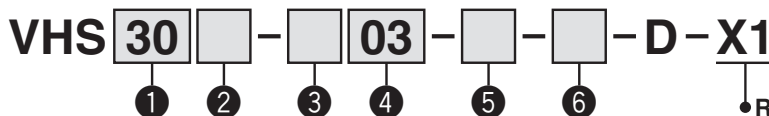

● Red body + Flame resistant

· Option/Semi-standard: Select one each for a to f.  
 · Option/Semi-standard symbol: When more than one specification is required, indicate in alphanumeric order.  
 Example) VHS30-N03-BS-RZ-D-X1

	Symbol	Description	①					
			Body size					
			20	30	40	50		
②	—	Single action	●	●	●	●		
	W	Double action	●	●	●	●		
+								
③	—	Rc*1	●	●	●	●		
	N	NPT	●	●	●	●		
	F	G	●	●	●	●		
+								
④	01	1/8	●	—	—	—		
	02	1/4	●	●	●	—		
	03	3/8	—	●	●	—		
	04	1/2	—	—	●	—		
	06	3/4	—	—	●	●		
10	1	—	—	—	●			
+								
⑤	a	Mounting	—	Without mounting option	●	●	●	●
			B	With bracket	●	●	●	●
+								
⑤	b	Silencer	—	Without silencer	●	●	●	●
			S	With built-in silencer (for EXH port)	●	●	●	●
+								
⑥	c	Handle colour	—	Red	●	●	●	●
			K	Black	●	●	●	●
	+							
	d	Handle material	—	Resin	●	●	●	●
			M	Metal	●	●	●	●
+								
e	Flow direction	—	Flow direction: Left to right	●	●	●	●	
		R	Flow direction: Right to left	●	●	●	●	
+								
f	Pressure unit	—	Product label in SI units: MPa	●	●	●	●	
		Z*2	Product label in imperial units: psi	○*3	○*3	○*3	○*3	

\*1 The pipe thread type for the EXH port is G.

\*2 For the pipe thread type: NPT only. This product is for overseas use only according to the New Measurement Act. (The SI unit type is provided for use in Japan.)

\*3 ○: For the pipe thread type: NPT only



# VHS20/30/40/50-D Series Specific Product Precautions 1

Be sure to read this before handling the products. Refer to the back cover for safety instructions. For 3/4/5-port solenoid valve precautions, refer to the “Handling Precautions for SMC Products” and the “Operation Manual” on the SMC website: <https://www.smcworld.com>

## Precautions on Design

### Warning

- Do not supply air pressure from ports other than the 1 (P) port.**  
The valve will malfunction when air pressure is supplied from other ports.
- We recommend using a lock with a shackle diameter of Ø 5 or more. If a lock with a shackle diameter of less than Ø 5 is to be used, please test it on the actual machine.**

## Installation and Adjustment

### Caution

- The valve must be switched to each position instantly and securely. Stopping the handle between the extreme positions may cause a malfunction.**
- Double action type requires two actions (push the handle and turn it). Confirm that the handle is pushed properly before turning it. If the handle is not pushed properly to the end, the internal parts will be broken by turning the handle.**
- Tighten the 2 holding screws on the spacer with bracket or spacer evenly.**  
Tighten them to the recommended tightening torque. Insufficient tightening torque may result in loosening or sealing failure. Excessive tightening torque may damage the thread, etc.

#### Recommended Tightening Torque

Unit: N·m

Applicable model	VHS20 [AC20]	VHS30 [AC30]	VHS40 [AC40]	VHS40-06 [AC40-06]	VHS50 [AC50/AC60]
Spacer with bracket part number	Y200T-D	Y300T-D	Y400T-D	Y500T-D	Y600T-D
Spacer part number	Y200-D	Y300-D	Y400-D	Y500-D	Y600-D
Torque	0.36 ±0.036	1.2 ±0.05	1.2 ±0.05	1.4 ±0.05	2.0 ±0.1

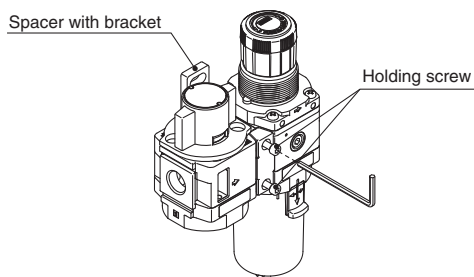

## Piping

### Warning

#### 1. Piping load and moment

Avoid any torsional or bending moments other than those caused by the equipment's own weight as failure to do so may result in damage.

Support external piping separately.

If moment application is unavoidable during operation, the moment should be lower than the max. moment shown below. Piping materials without flexibility, such as steel tube piping, are prone to being affected by excess moment loads or vibrations from the piping side. Use flexible tubing in between to avoid such effects.

Unit: N·m

Applicable model	VHS20 [AC20]	VHS30 [AC30]	VHS40 [AC40]	VHS40-06 [AC40-06]	VHS50 [AC50/AC60]
Max. moment (M)	14.5	16	19.5	35	45

Max. moment (M) = Length (L) x Load (F)

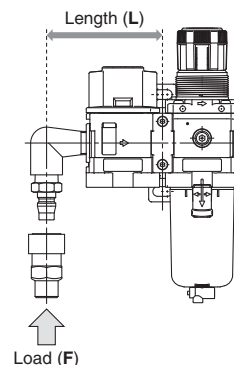

#### 2. Before piping is connected, the pipes should be thoroughly blown through with air (flushing) or washed to remove chips, cutting oil and other debris from inside.

Should they remain, they could cause a malfunction.

#### 3. When connecting pipes and fittings, etc., be sure that neither chips from the pipe threads nor sealing material get inside the valve.

When using sealant tape, leave 1.5 to 2 thread ridges exposed at the end of the pipe/fitting.

#### 4. Connect piping/fittings using the recommended torque while holding the female thread side tightly.

Insufficient tightening torque can result in loose piping or sealing failure. Over tightening may break the thread. If the female side is not held while tightening, excessive force will be applied to the bracket directly, resulting in breakage.

#### Recommended Tightening Torque

Unit: N·m

Connection thread	1/8	1/4	3/8	1/2	3/4	1
Torque	7 to 9	12 to 14	22 to 24	28 to 30	28 to 30	36 to 38



# VHS20/30/40/50-D Series

## Specific Product Precautions 2

Be sure to read before handling. Refer to back cover for Safety Instructions and "Handling Precautions for SMC Products" (M-E03-3) for 3/4/5 Port Solenoid Valve Precautions on the SMC website: <https://www.smc.eu>

### Piping

#### Warning

5. When an SMC One-touch fitting is used, refer to the operation manual for the One-touch fitting.
6. Silencer is recommended in the exhaust port.

When mounting a built-in resin silencer (VHS series/optional), tighten it by hand, and then use a tool on the width across flats of the octagonal part to tighten it additionally until it is attached firmly on the end. When mounting the resin silencers (AN series), use a tool on the width across flats of the hexagonal part to tighten it an additional 1/4 turn after tightening the silencer by hand.

When installing One-touch fittings (KQ2 series), add a 1/2 turn after tightening it by hand. Excess tightening torque may damage the resin silencers or the threads of the exhaust port.

### Air Supply

#### Warning

1. Air containing a large amount of drainage can cause a malfunction. Install an air dryer or after-cooler on the inlet side of the product.

#### Caution

1. Use an air filter with 5  $\mu\text{m}$  or less filtration rating on the inlet side to avoid any damage to the seat caused by dust.
2. Install a mist separator on the inlet side to remove carbon powder from the compressor or other equipment. An excessive amount of carbon dust ingress via the inlet may cause the valve to malfunction.

Refer to "SMC Air Preparation System" for further details on compressed air quality.

### Operating Environment

#### Warning

1. Do not use in an atmosphere containing corrosive gases, chemicals, sea water, water, water steam, or where there is direct contact with any of these.
2. Do not use in explosive atmospheres.
3. Do not use in locations subject to vibration or impact.
4. A protective cover should be used to shield the product from direct sunlight.
5. Remove any sources of excessive heat.
6. Employ suitable protective measures in locations where there is contact with water droplets, oil, welding spatter, etc.
7. Install a silencer into exhaust port to prevent the ingress of dust if there is a lot of dust in the atmosphere.

If dust enters the valve via exhaust port, it may cause air leakage.

If any ambient environments from 1 to 7 mentioned above are true for your operating conditions, select the metal handle type for your safety.

### Maintenance

#### Warning

1. When equipment is to be removed, first confirm that measures are in place to prevent dropping of driven objects and run-away of equipment, etc. Then cut the supply air pressure and electric power, and exhaust all compressed air from the system using its residual pressure release function.



When the equipment is to be started again after remounting or replacement, first confirm that measures are in place to prevent lurching of actuators and then confirm that equipment operates normally.

2. Do not disassemble the product.

It will cause damage to the product and result in operation failure.

## Safety Instructions

These safety instructions are intended to prevent hazardous situations and/or equipment damage. These instructions indicate the level of potential hazard with the labels of “Caution,” “Warning” or “Danger.” They are all important notes for safety and must be followed in addition to International Standards (ISO/IEC)<sup>1)</sup>, and other safety regulations.

 <b>Caution:</b>	<b>Caution</b> indicates a hazard with a low level of risk which, if not avoided, could result in minor or moderate injury.
 <b>Warning:</b>	<b>Warning</b> indicates a hazard with a medium level of risk which, if not avoided, could result in death or serious injury.
 <b>Danger:</b>	<b>Danger</b> indicates a hazard with a high level of risk which, if not avoided, will result in death or serious injury.

- 1) ISO 4414: Pneumatic fluid power – General rules relating to systems.  
ISO 4413: Hydraulic fluid power – General rules relating to systems.  
IEC 60204-1: Safety of machinery – Electrical equipment of machines.  
(Part 1: General requirements)  
ISO 10218-1: Manipulating industrial robots - Safety.  
etc.

## Warning

### 1. The compatibility of the product is the responsibility of the person who designs the equipment or decides its specifications.

Since the product specified here is used under various operating conditions, its compatibility with specific equipment must be decided by the person who designs the equipment or decides its specifications based on necessary analysis and test results. The expected performance and safety assurance of the equipment will be the responsibility of the person who has determined its compatibility with the product. This person should also continuously review all specifications of the product referring to its latest catalogue information, with a view to giving due consideration to any possibility of equipment failure when configuring the equipment.

### 2. Only personnel with appropriate training should operate machinery and equipment.

The product specified here may become unsafe if handled incorrectly. The assembly, operation and maintenance of machines or equipment including our products must be performed by an operator who is appropriately trained and experienced.

### 3. Do not service or attempt to remove product and machinery/equipment until safety is confirmed.

1. The inspection and maintenance of machinery/equipment should only be performed after measures to prevent falling or runaway of the driven objects have been confirmed.
2. When the product is to be removed, confirm that the safety measures as mentioned above are implemented and the power from any appropriate source is cut, and read and understand the specific product precautions of all relevant products carefully.
3. Before machinery/equipment is restarted, take measures to prevent unexpected operation and malfunction.

### 4. Contact SMC beforehand and take special consideration of safety measures if the product is to be used in any of the following conditions.

1. Conditions and environments outside of the given specifications, or use outdoors or in a place exposed to direct sunlight.
2. Installation on equipment in conjunction with atomic energy, railways, air navigation, space, shipping, vehicles, military, medical treatment, combustion and recreation, or equipment in contact with food and beverages, emergency stop circuits, clutch and brake circuits in press applications, safety equipment or other applications unsuitable for the standard specifications described in the product catalogue.
3. An application which could have negative effects on people, property, or animals requiring special safety analysis.
4. Use in an interlock circuit, which requires the provision of double interlock for possible failure by using a mechanical protective function, and periodical checks to confirm proper operation.

## Caution

### 1. The product is provided for use in manufacturing industries.

The product herein described is basically provided for peaceful use in manufacturing industries.  
If considering using the product in other industries, consult SMC beforehand and exchange specifications or a contract if necessary.  
If anything is unclear, contact your nearest sales branch.

## Limited warranty and Disclaimer/Compliance Requirements

The product used is subject to the following “Limited warranty and Disclaimer” and “Compliance Requirements”. Read and accept them before using the product.

### Limited warranty and Disclaimer

1. The warranty period of the product is 1 year in service or 1.5 years after the product is delivered, whichever is first.<sup>2)</sup> Also, the product may have specified durability, running distance or replacement parts. Please consult your nearest sales branch.
  2. For any failure or damage reported within the warranty period which is clearly our responsibility, a replacement product or necessary parts will be provided. This limited warranty applies only to our product independently, and not to any other damage incurred due to the failure of the product.
  3. Prior to using SMC products, please read and understand the warranty terms and disclaimers noted in the specified catalogue for the particular products.
- 2) Vacuum pads are excluded from this 1 year warranty.  
A vacuum pad is a consumable part, so it is warranted for a year after it is delivered. Also, even within the warranty period, the wear of a product due to the use of the vacuum pad or failure due to the deterioration of rubber material are not covered by the limited warranty.

### Compliance Requirements

1. The use of SMC products with production equipment for the manufacture of weapons of mass destruction (WMD) or any other weapon is strictly prohibited.
2. The exports of SMC products or technology from one country to another are governed by the relevant security laws and regulations of the countries involved in the transaction. Prior to the shipment of a SMC product to another country, assure that all local rules governing that export are known and followed.

## Caution

### SMC products are not intended for use as instruments for legal metrology.

Measurement instruments that SMC manufactures or sells have not been qualified by type approval tests relevant to the metrology (measurement) laws of each country.  
Therefore, SMC products cannot be used for business or certification ordained by the metrology (measurement) laws of each country.

## Safety Instructions

Be sure to read “Handling Precautions for SMC Products” (M-E03-3) before using.

## SMC Corporation (Europe)

<b>Austria</b>	+43 (0)2262622800	www.smc.at	office@smc.at
<b>Belgium</b>	+32 (0)33551464	www.smc.be	info@smc.be
<b>Bulgaria</b>	+359 (0)2807670	www.smc.bg	office@smc.bg
<b>Croatia</b>	+385 (0)13707288	www.smc.hr	office@smc.hr
<b>Czech Republic</b>	+420 541424611	www.smc.cz	office@smc.cz
<b>Denmark</b>	+45 70252900	www.smc.dk.com	smc@smcdk.com
<b>Estonia</b>	+372 6510370	www.smc.pneumatics.ee	smc@info@smcee.ee
<b>Finland</b>	+358 207513513	www.smc.fi	smc@info@smc.fi
<b>France</b>	+33 (0)164761000	www.smc-france.fr	info@smc-france.fr
<b>Germany</b>	+49 (0)61034020	www.smc.de	info@smc.de
<b>Greece</b>	+30 210 2717265	www.smchellas.gr	sales@smchellas.gr
<b>Hungary</b>	+36 23513000	www.smc.hu	office@smc.hu
<b>Ireland</b>	+353 (0)14039000	www.smcautomation.ie	sales@smcautomation.ie
<b>Italy</b>	+39 03990691	www.smc.italia.it	mailbox@smc.italia.it
<b>Latvia</b>	+371 67817700	www.smc.lv	info@smc.lv

<b>Lithuania</b>	+370 5 2308118	www.smclt.lt	info@smclt.lt
<b>Netherlands</b>	+31 (0)205318888	www.smc.nl	info@smc.nl
<b>Norway</b>	+47 67129020	www.smc-norge.no	post@smc-norge.no
<b>Poland</b>	+48 222119600	www.smc.pl	office@smc.pl
<b>Portugal</b>	+351 214724500	www.smc.eu	apoioclientept@smc.smces.es
<b>Romania</b>	+40 213205111	www.smcromania.ro	smcromania@smcromania.ro
<b>Russia</b>	+7 (812)3036600	www.smc.eu	sales@smcru.com
<b>Slovakia</b>	+421 (0)413213212	www.smc.sk	office@smc.sk
<b>Slovenia</b>	+386 (0)73885412	www.smc.si	office@smc.si
<b>Spain</b>	+34 945184100	www.smc.eu	post@smc.smces.es
<b>Sweden</b>	+46 (0)86031240	www.smc.nu	smc@smc.nu
<b>Switzerland</b>	+41 (0)523963131	www.smc.ch	info@smc.ch
<b>Turkey</b>	+90 212 489 0 440	www.smc.pnomatik.com.tr	info@smcpnomatik.com.tr
<b>UK</b>	+44 (0)845 121 5122	www.smc.uk	sales@smc.uk

**South Africa** +27 10 900 1233    www.smcza.co.za    zasales@smcza.co.za